



CATÁLOGO
DE PRODUTOS
Videocirurgia

**Suprindo hoje,
pensando no
amanhã!**

ÍNDICE

TROCARTES E BAINHAS	4
TESOURAS	8
PORTA-AGULHAS	10
PINÇAS	12
CÂNULAS	22
EMPUNHADURAS	25
COMPLEMENTOS	27
VEDANTES	31
CAIXAS CIRÚRGICAS	33
ASPIRADORES	35
APLICADORES DE CLIP	37
ACESSÓRIOS	39
ENDOSCÓPIOS RÍGIDOS	41

CATÁLOGO
DE PRODUTOS
Esterilização (CME)



Trocartes e
Bainhas

TROCARTES E BAINHAS



Obturador Ponta Piramidal Ø3mm 7,5cm (3") ou 12,5cm (5")

14-2243 e 14-1533

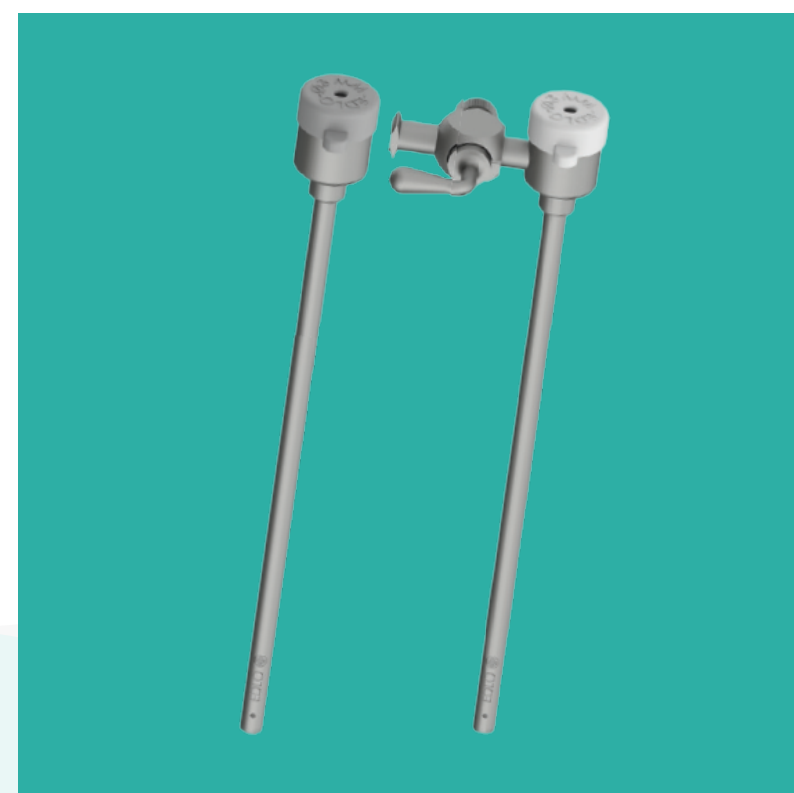

Cânula Diafragma Ø3mm Lisa C/ ou S/ Torneira, 5cm (2") ou 10cm (4")

14-2242, 14-2245, 14-1532 e 14-2332



Obturador Ponta Piramidal Ø5mm 8cm (3") ou 14,5cm (5 3/4")

14-1188 e 14-1014

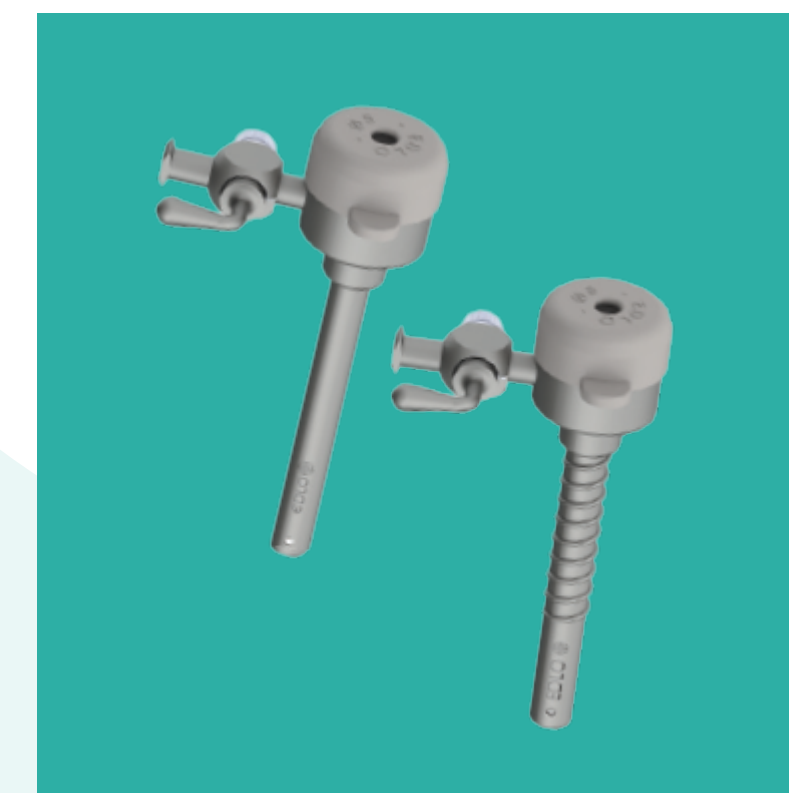

Cânula Diafragma Ø5mm Lisa ou Rosqueável, C/ ou S/ Torneira, 4,5cm (2 3/4") ou 11cm (4 1/2")

14-2598, 14-2599, 14-1184, 14-1185, 14-1013, 14-1019, 14-1176 e 4-1177



Obturador Ø5mm P. Piramidal ou Protegida, 17cm (6 3/4"), 22cm (8 3/4"), 20cm (8"), 26cm (10 1/4"), 12,5cm (5") ou 15,5cm (6 1/2")

14-1026, 14-1199, 14-2492, 14-3027, 14-1194 e 14-1468



Cânula Ø5mm Janela Lisa ou Rosqueável, C/ ou S/ Torneira, 11cm (4 1/2"), 14cm (5 1/2") ou 4,5cm (2 3/4")

14-1208, 14-1207, 14-1179, 14-1178, 14-2493, 14-2746, 14-2650, 14-2833, 14-1186 e 14-1187

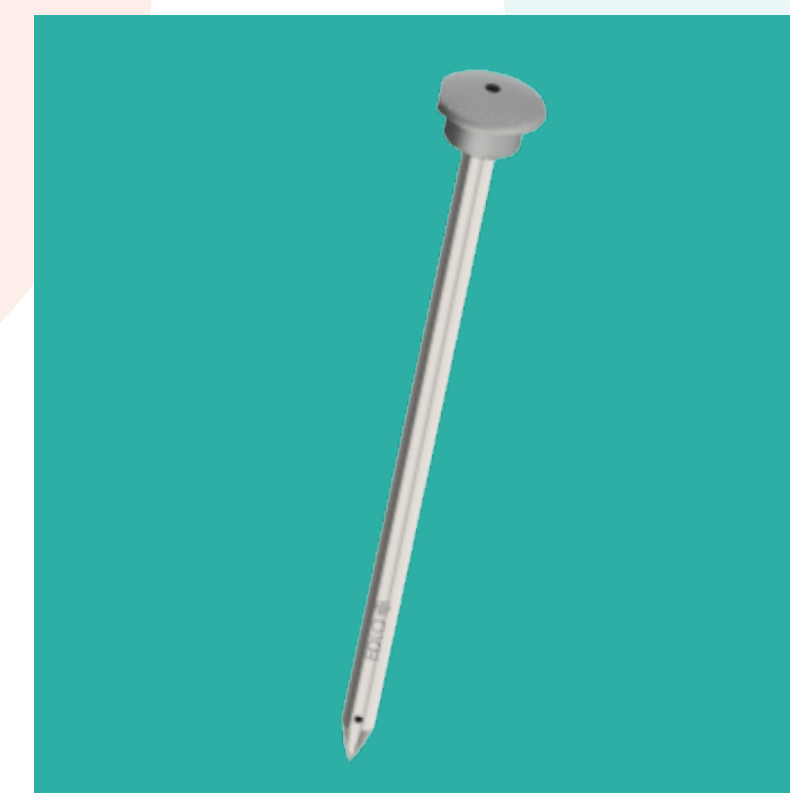

Obturador Ø6,5mm Ponta Piramidal 14,5cm (5 3/4") ou 8cm (3")

14-2357 e 14-1477

TROCARTES E BAINHAS



Cânula Ø6,5mm Diafragma Lisa ou Rosqueável c/ ou s/ Torneira 10,5cm (4 1/2") ou 4,5cm (2 3/4")

14-2333, 14-2365, 14-1469 e 14-2334



Obturador Ø6,5mm Ponta Piramidal ou Protegida 17cm (6 3/4") ou 18,5cm (7 1/4")

14-2363 e 14-2478



Cânula Ø6,5mm Janela Lisa ou Rosqueável c/ ou s/ Torneira 10,5cm (4 1/2")

14-2356, 14-2364, 14-2584 e 14-2698



Obturador Ø10mm Ponta Piramidal 16cm (6 1/4")

14-1017



Cânula Ø10mm Diafragma Lisa ou Rosqueável c/ ou s/ Torneira 11cm (4 1/2")

14-1016, 14-1022, 14-1180 e 14-1181



Obturador Ø10mm Ponta Piramidal ou Protegida 23cm (9"), 17cm (6 3/4"), 21cm (8 1/4") ou 26cm (10 1/4")

14-1202, 14-1203, 14-1443 e 4-1445



Cânula Ø10mm Janela Lisa, Rosqueável ou Manual c/ ou s/ Torneira 10cm (4 1/2") ou 14cm (5 1/2")

14-1182, 14-1183, 14-1200, 14-1201, 14-2221, 14-2223, 14-1408, 14-1409, 14-2651 e 14-3225



**Obturador Ø12mm
Ponta Piramidal 16cm
(6 1/4") ou 20cm (8")**

14-1198 e 14-1444



**Cânula Ø12mm Diafragma
Lisa ou Rosqueável, c/ ou
s/ Torneira, 11cm (4 1/2") ou
14cm (5 1/2")**

14-3229, 14-2477 e 14-1405



**Obturador Ø12mm Ponta
Protegida ou Piramidal, 25cm
(10"), 19,5cm (7 3/4"), 23cm (9")
e 28cm (11")**

14-2354, 14-2647, 14-2646 e 14-2748



**Cânula Janela Lisa ou
Rosqueável c/ou s/ Torneira,
11cm (4 1/2") ou 14cm (5 1/2")**

14-2642, 14-2643, 14-2825, 14-3226,
14-2644, 14-2645, 14-3227 e 14-3228



Tesouras

TESOURAS

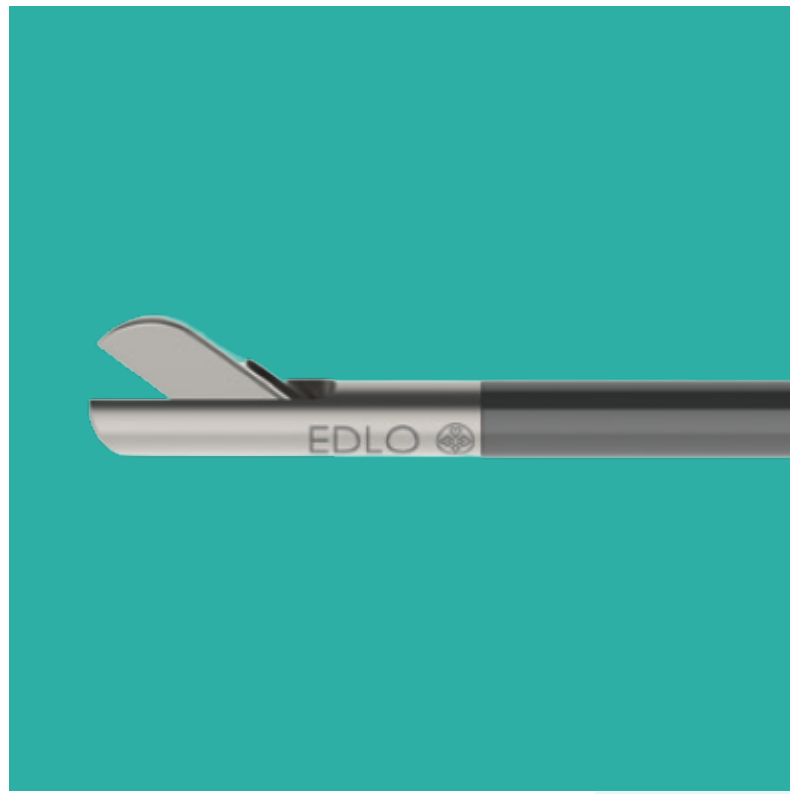

**Tesoura Metzenbaum
Ø3mm**

14-5171, 14-5170, 14-2288 e
14-2287



**Tesoura Metzenbaum
Isol. Reta Ø5mm**

14-5122, 14-5123, 14-5124,
14-2951, 14-2299 e 14-2952

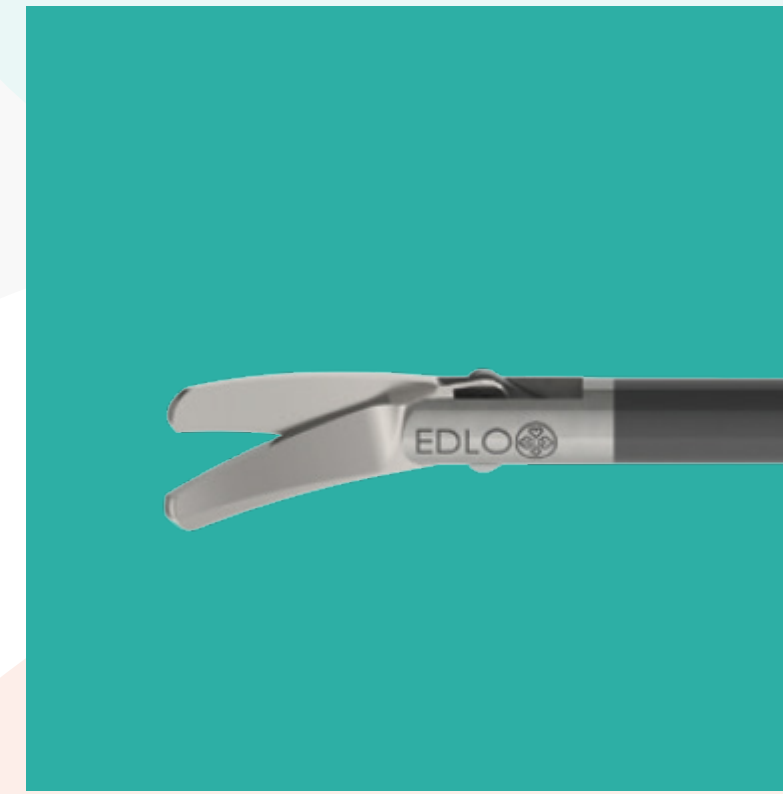

**Tesoura Metzenbaum
Isol. Curva Ø5mm**

14-5002, 14-5000, 14-5001,
14-2812, 14-1591 e 14-2950



**Tesoura Metzenbaum
Lâmina Longa Curva
Ø5mm**

14-5129, 14-5130, 14-3161 e
14-3224



**Tesoura Tipo
Gancho Ø5mm**

14-5125 e 14-2302



**Tesoura Tipo
Gancho Serrilhada
Ø5mm**

14-5126 e 14-2303

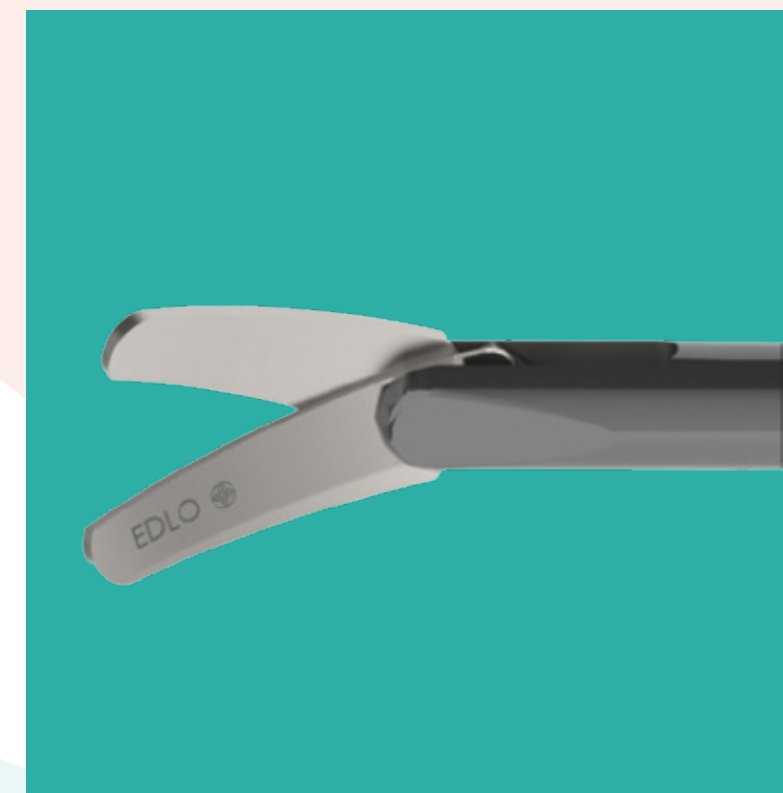

**Tesoura
Metzenbaum Isol.
Curva Ø10mm**

14-5127, 14-5128, 14-3051 e
14-3067



Porta-Agulhas



Porta Agulhas Reto Longitudinal e Mathieu Ø3mm. Compr. e Haste Int.: 20cm (8") e 36cm (14")

14-2250, 14-2241, 14-2290, 14-2291, 14-2379, 14-3003, 14-2290 e 14-2291



Porta Agulhas Curvo Videa Longitudinal e Mathieu Ø5mm Compr. e Haste Int.: 20cm (8"), 36cm (4") e 42cm (16 1/2")

14-1460, 14-1215, 14-1437, 14-3029, 14-2997, 14-2872, 14-3212, 14-2533, 14-2588, 14-3029, 14-2997 e 14-2872



Porta Agulhas Reto Videa Longitudinal e Mathieu Ø5mm Compr. e Haste Int.: 20cm (8"), 36cm (4") e 42cm (16 1/2")

14-1470, 14-0948, 14-1220, 14-3001, 14-3012, 14-3023, 14-3213, 14-2680, 14-3214, 14-3001, 14-3012 e 14-3023



Pinça Contra Porta Agulhas Ø5mm Compr. e Haste Int.: 20cm (8"), 36cm (4") e 42cm (16 1/2")

14-5175, 14-5176, 14-5177, 14-3015, 14-3016 e 14-3017



Pinças

PINÇAS



Pinça de Apreensão de Ø3mm

14-5160, 14-5161, 14-5162, 14-5163, 14-2289 e 14-2284



Pinça de Apreensão Especial Vesícula Ø3mm

14-5166 e 14-2890



Pinça de Bakey Ø3mm

14-5167, 14-5168, 14-2318 e 14-2319

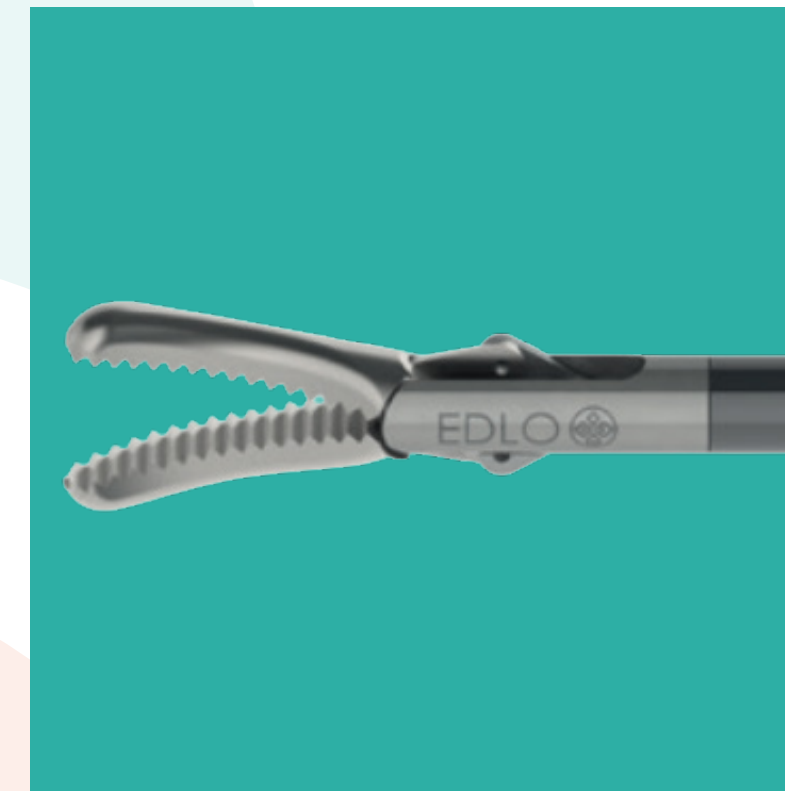

Pinça Maryland de Dissecção Ø3mm

14-5164, 14-5165, 14-3323 e 14-2286



Pinça de Apreensão Fenestrada Ø3mm

14-5169 e 14-3130



Pinça Aplicadora de Nó Serrilhada Isol. Ø5mm

14-5050, 14-5051, 14-2237 e 14-3175



Pinça de Apreensão 4X4 Dentes Ø5mm

14-5065, 14-5066 e 14-2236

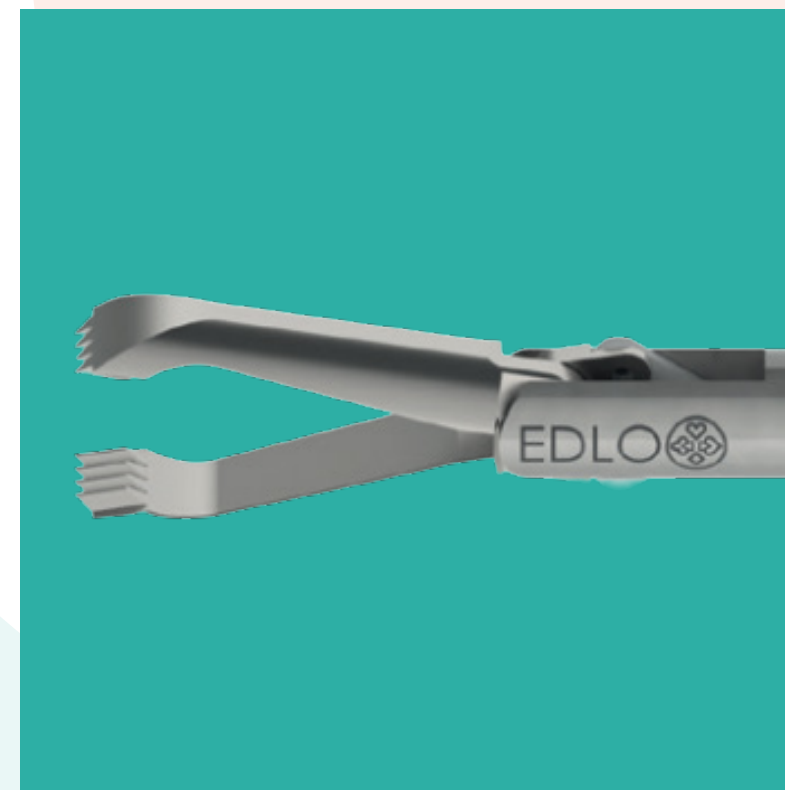

Pinça de Apreensão Tipo Allis Isol. Ø5mm

14-5069, 14-5070, 14-5071, 14-2921, 14-1552 e 14-2920

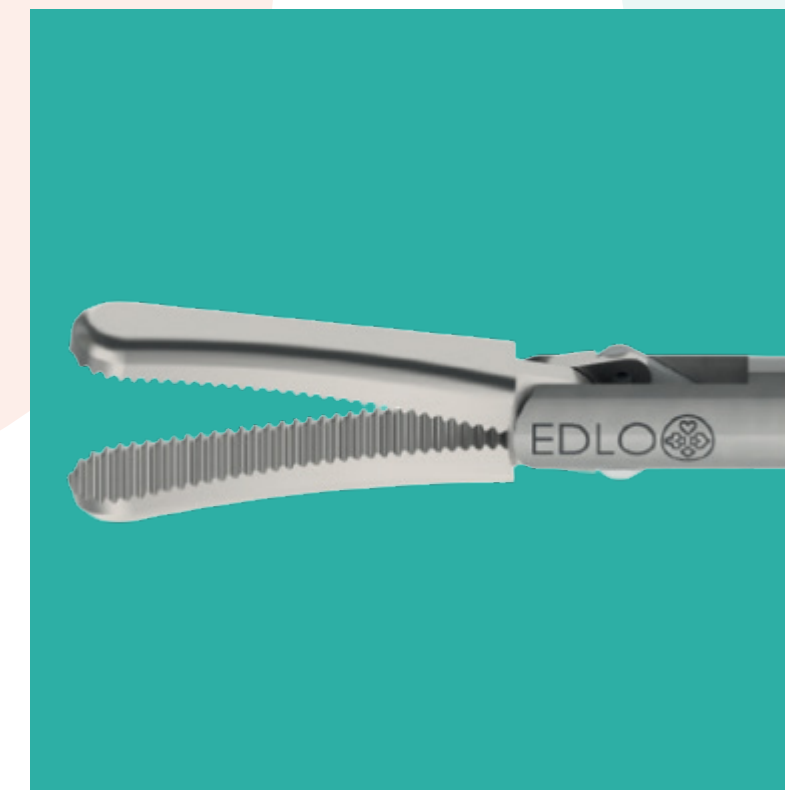

Pinça de Apreensão Atraumática Especial Ø5mm

14-5067, 14-5068, 14-1588 e 14-2938



Pinça de Apreensão Dentada 2X4 Serrilhada Isol. Ø5mm

14-5019, 14-5020, 14-5021, 14-2911, 14-1547 e 14-2912



Pinça de Apreensão Especial Vesícula Fenestrada Isol. Ø5mm

14-5003, 14-5004, 14-1550 e 14-2917



Pinça de Apreensão Especial Vesícula Fenestrada Ø5mm

14-5032, 14-5033, 14-5034, 14-5035, 14-5036, 14-5037, 14-2918, 14-1551 e 14-2919

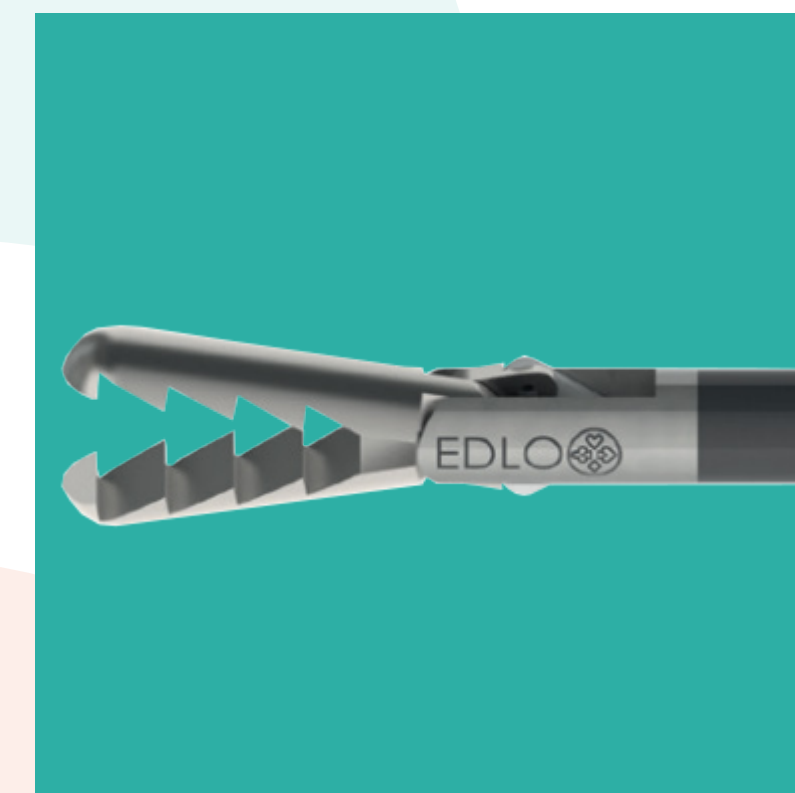

Pinça de Apreensão e Extração Isol. Dentada Tipo Cremalheira Ø5mm

14-5082, 14-5083, 14-5084, 14-5085, 14-1606 e 14-2936

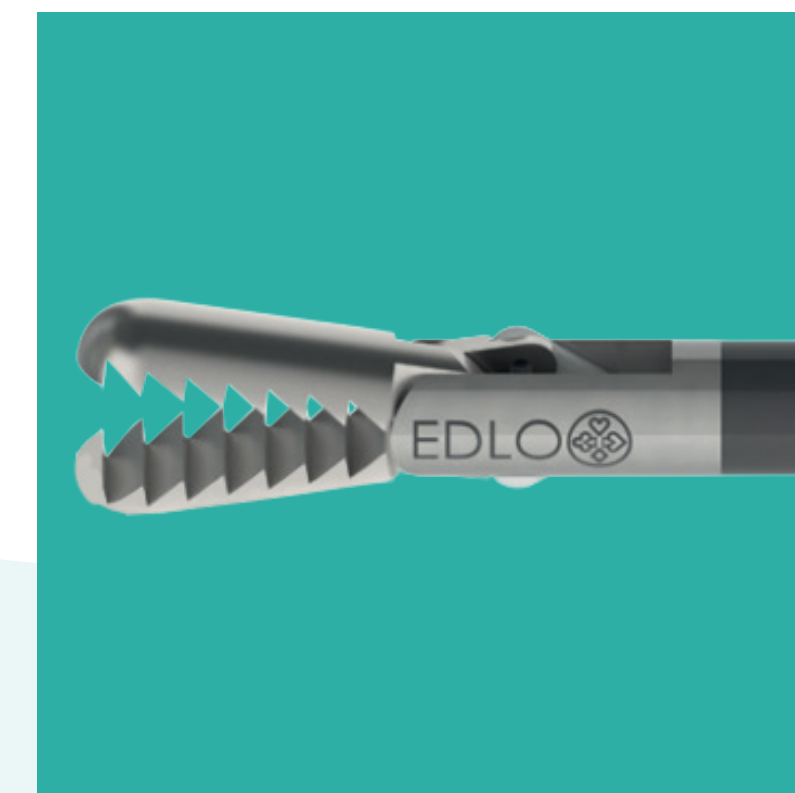

Pinça de Apreensão e Extração Isol. Ø5mm

14-5052, 14-5053, 14-5054, 14-5055, 14-5056, 14-5057, 14-2922, 14-1553 e 4-3237

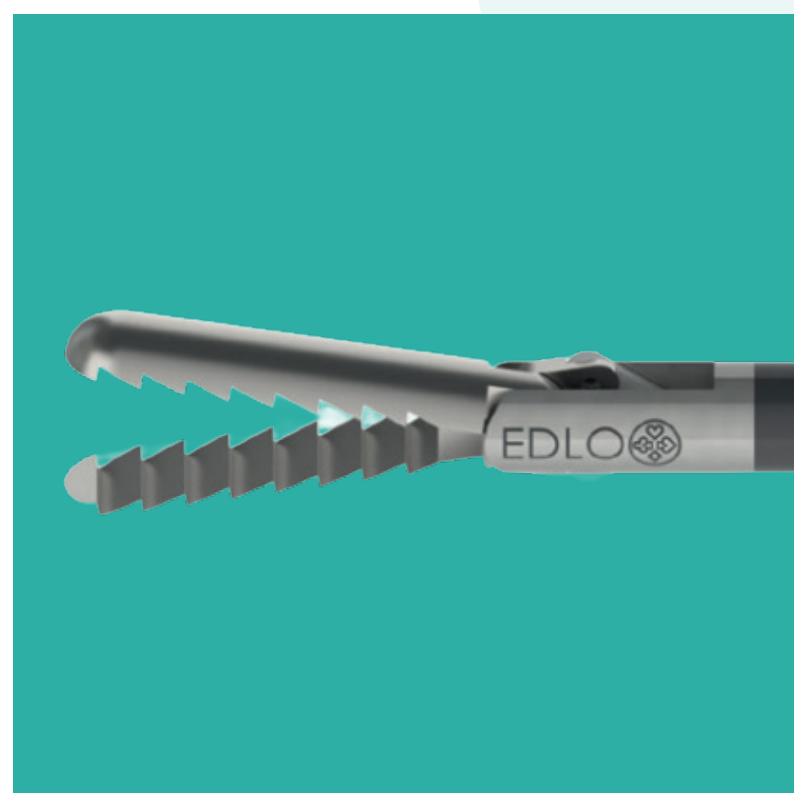

Pinça de Apreensão e Extração Longa Isol. Dentada Tipo Cremalheira Ø5mm

14-5024, 14-5025, 14-5026, 14-5027, 14-1610 e 14-2937



Pinça de Apreensão Pediátrica Ø5mm

14-5063, 14-5064 e 14-2903

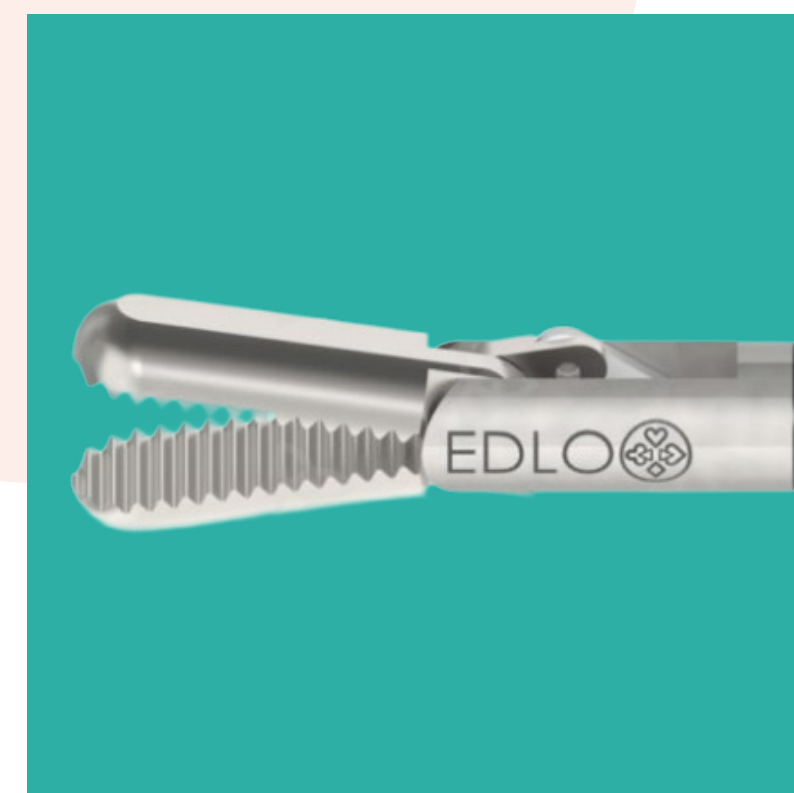

Pinça de Apreensão Reforçada Isol. Ø5mm

14-5005, 14-5006, 14-5007, 14-5008, 14-2909 e 14-1546

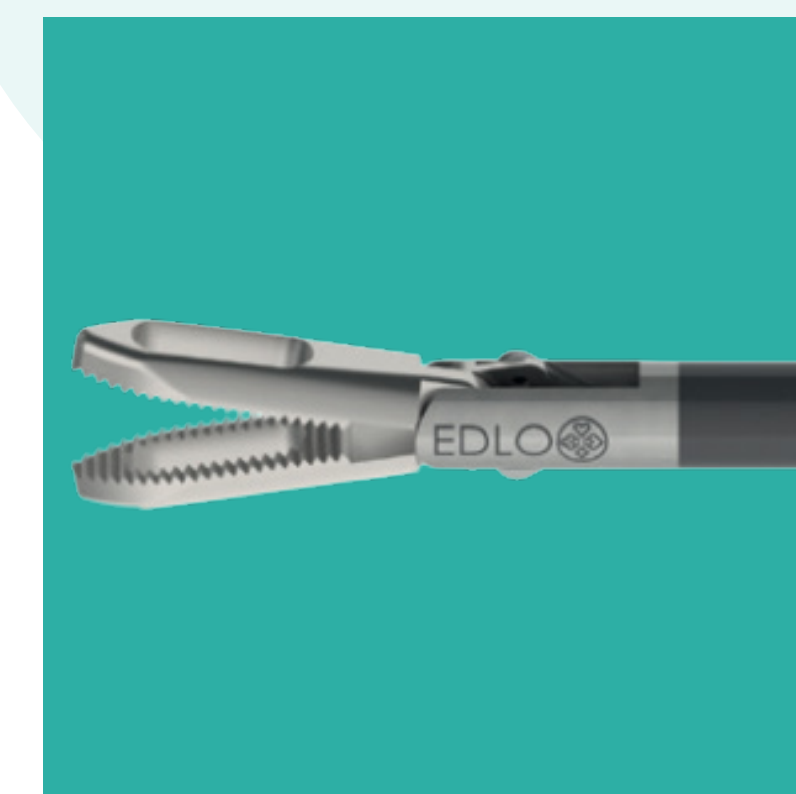

Pinça de Apreensão Serrilhada Fenestrada Ø5mm

14-5115, 14-5116, 14-3258 e 14-3259



**Pinça de Apreensão
Reforçada Isol.
Longa Ø5mm**

14-5076, 14-5077,
14-5078, 14-5079,
14-5080, 14-5081,
14-2933, 14-1600 e
14-2935



**Pinça Atraumática
de Dissecação Isol.
Ø5mm**

14-5038, 14-5039,
14-5040, 14-2994, 14-1543
e 14-2905



**Pinça Atraumática
de Bakey Ø5mm
Bocas 20mm,
30mm e 40mm**

14-5074, 14-2455,
14-5072, 14-5073,
14-2409, 14-3060,
14-5075 e 14-2408



**Pinça Babcock
Pediátrica Ø5mm**

14-5060, 14-5061,
14-5062, 14-2906,
14-1544 e 14-2908



**Pinça p/ Biópsia
Tipo Sacabocado
Ø5mm**

14-5086, 14-5087,
14-2282 e 14-3241



**Pinça p/ Biópsia
Tipo Colher 1X1 Isol.
Ø5mm**

14-5022, 14-5023, 14-1560
e 14-3034



**Pinça Crafoord de
Apreensão Ø5mm**

14-5120, 14-5121, 14-3262
e 14-3263

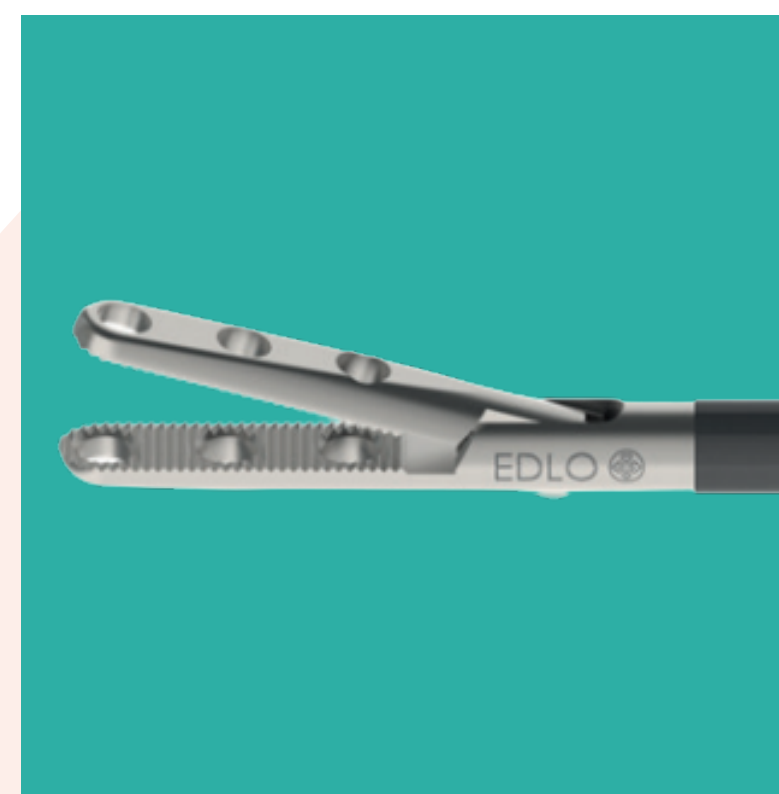

**Pinça Croce OLMI
Serrilhada SA
Ø5mm**

14-5107, 14-5108, 14-5109,
14-5110, 14-3254 e
14-3255

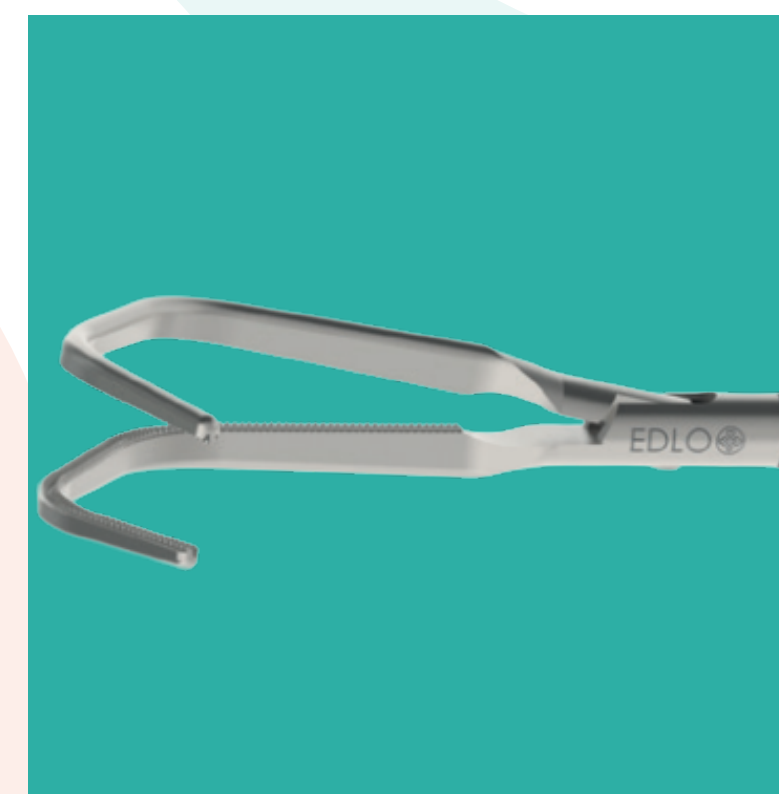

**Pinça de Bakey
Satinsky Ø5mm**

14-5119 e 14-3123

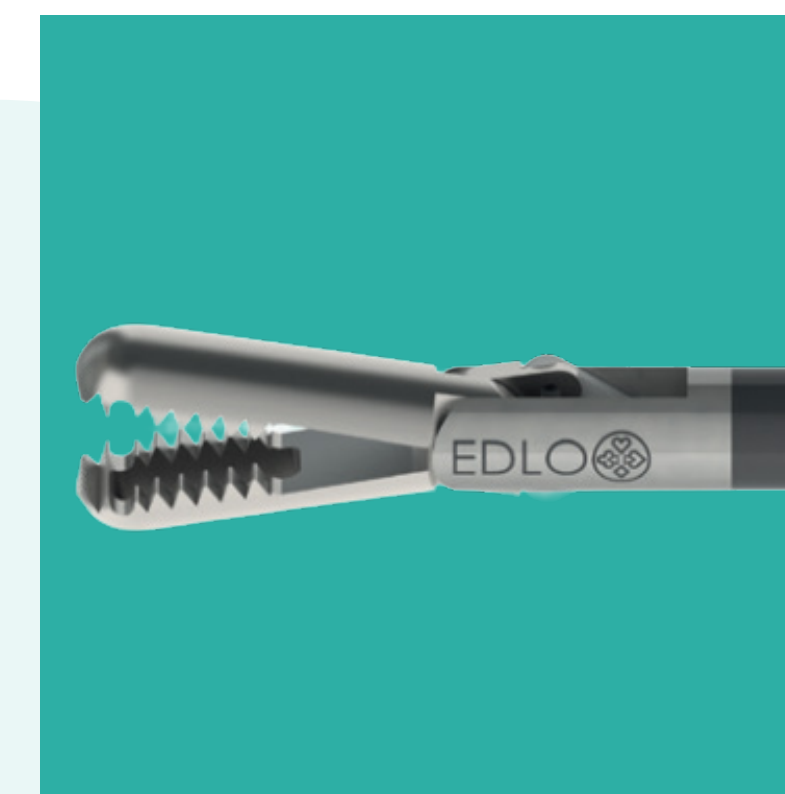

**Pinça Apreensão
Dentada e
Serrilhada
p/ Extração Isol.
Ø5mm**

14-5048, 14-5049 e
14-1555

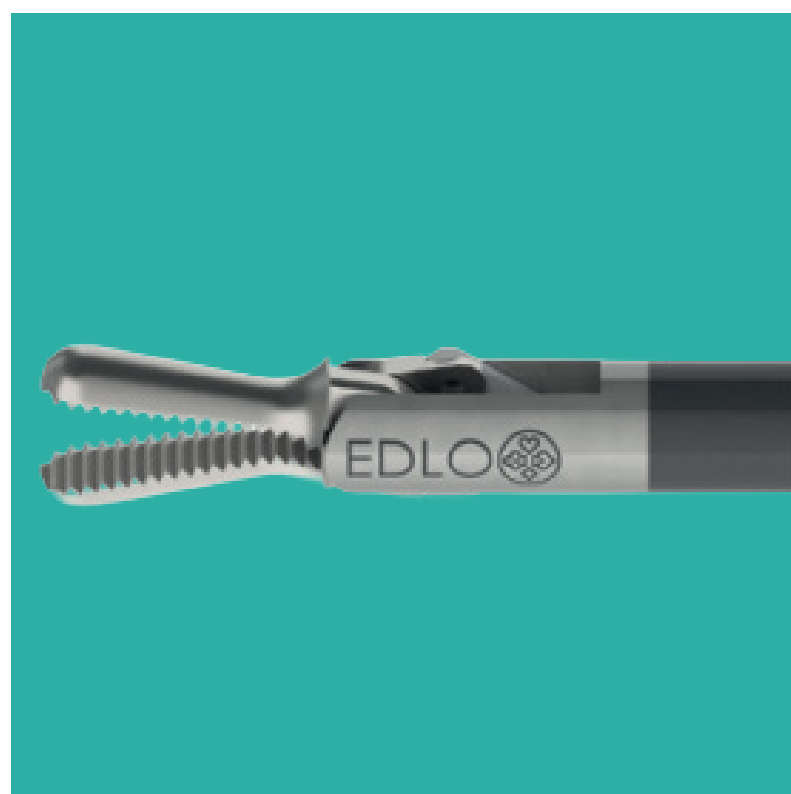

Pinça de Dissecção e Apreensão Delicada Serrilhada Isol. Ø5mm

14-5041, 14-5042, 14-5043, 14-2916, 14-1548 e 14-2976

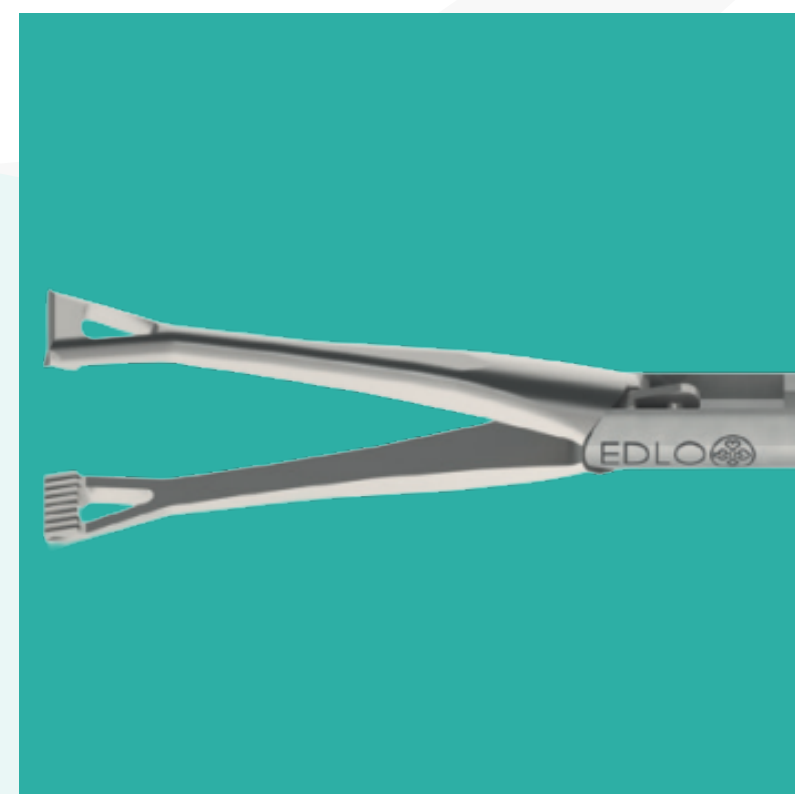

Pinça Duval Ø5mm

14-5111, 14-5112, 14-5113, 14-5114, 14-3256 e 14-3257



Pinça Fenestrada p/ Alça Intestinal Boca de 30mm Ø5mm

14-5028, 14-5029, 14-5030, 14-5031, 14-1556 e 14-2435



Pinça Fenestrada Dentada em Garra Isol. Ø5mm

14-5058, 14-5059, 14-1557

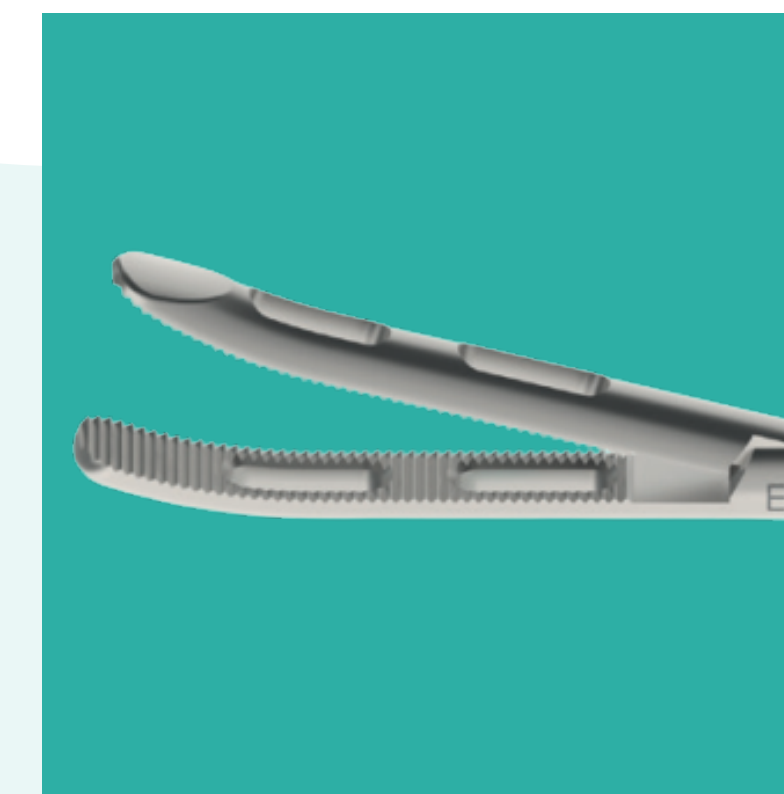

Pinça Fenestrada Especial Curva Ø5mm

14-5044, 14-5045, 14-5046, 14-5047, 14-2898 e 14-2437



Pinça Fenestrada Serrilhada Reta SA Ø5mm

14-5103, 14-5104, 14-5105, 14-5106, 14-3252 e 14-3253



Pinça Maryland de Dissecção Ø5mm

14-5012, 14-5013, 14-5014, 14-2927, 14-1558 e 14-2926

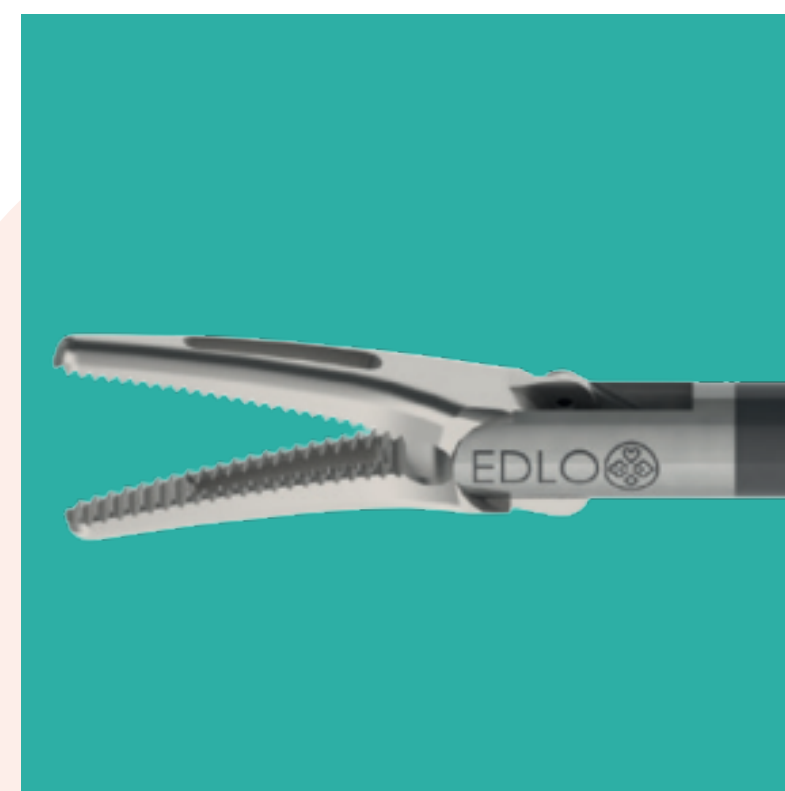

Pinça Maryland de Dissecção Fenestrada Ø5mm

14-5097, 14-5098, 14-3246 e 14-3247

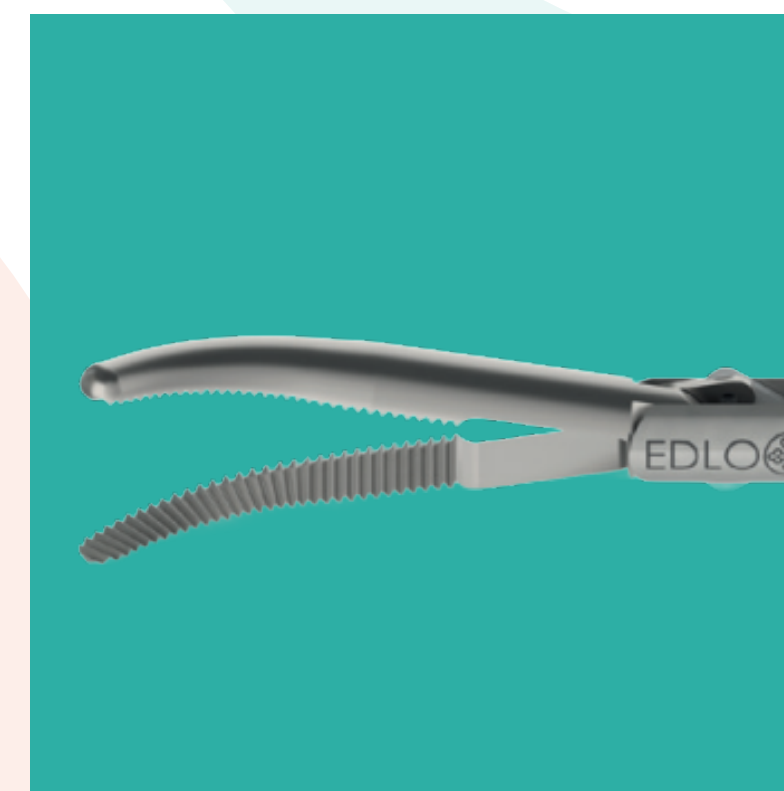

Pinça Maryland de Dissecção Longa Ø5mm

14-5091, 14-5092, 14-2934 e 14-1577

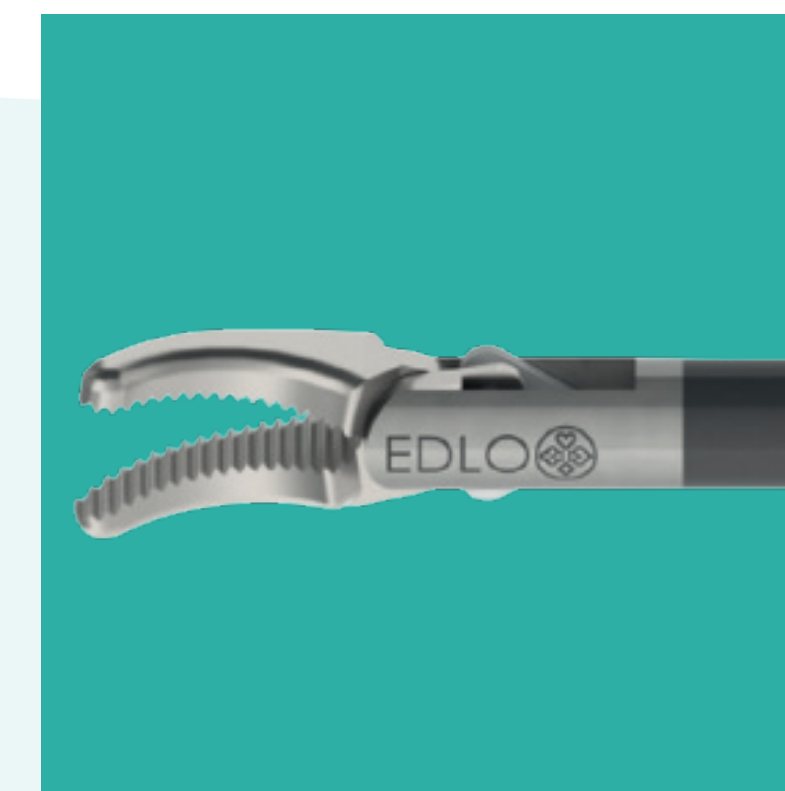

Pinça Maryland de Dissecção Pediátrica Ø5mm

14-5088, 14-5089, 14-5090, 14-3242, 14-1568 e 14-2930



Pinça Maryland de Dissecção Mixer Serrilhada Ø5mm

14-5095, 14-5096, 14-3244 e 14-3245



Pinça Mixer Boca 14,5mm Ø5mm

14-5010, 14-5009 e 14-5011



Pinça Mixer Longa Boca 25mm Ø5mm

14-5099, 14-5100, 14-3248 e 14-3249



Pinça Mixer Psalmon Boca 14,5mm Ø5mm

14-5101, 14-5102, 14-3250 e 14-3251



Pinça Mixer de Dissecção Parte Ativa Reduzida Ø5mm

14-5093, 14-5094, 14-3243 e 14-2311



Pinça p/ Apreensão de Tubos Ø5mm

14-5117, 14-5118, 14-3260 e 14-3261

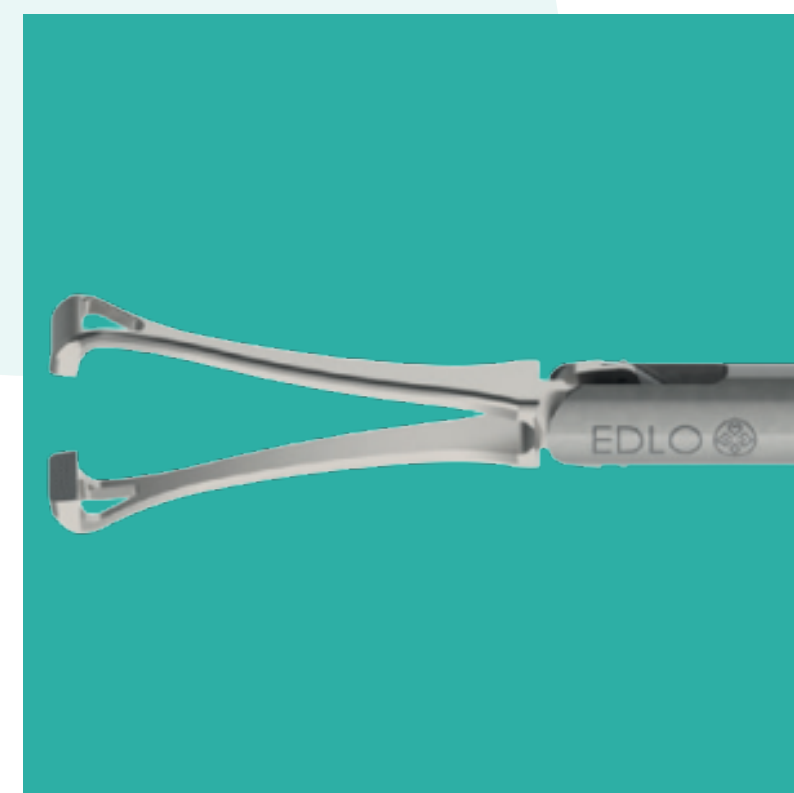

Pinça Babcock c/ Videira Ø10mm

14-5131, 14-5132, 14-5133, 14-5134, 14-3046 e 14-3305



Pinça Babcock c/ Serrilha de Bakey Ø10mm

14-5135, 14-5136 e 14-5138



Pinça Babcock c/ Serrilha Atraumática Ø10mm

14-5139, 14-5140, 14-5141, 14-5142, 14-3044 e 14-3063

PINÇAS

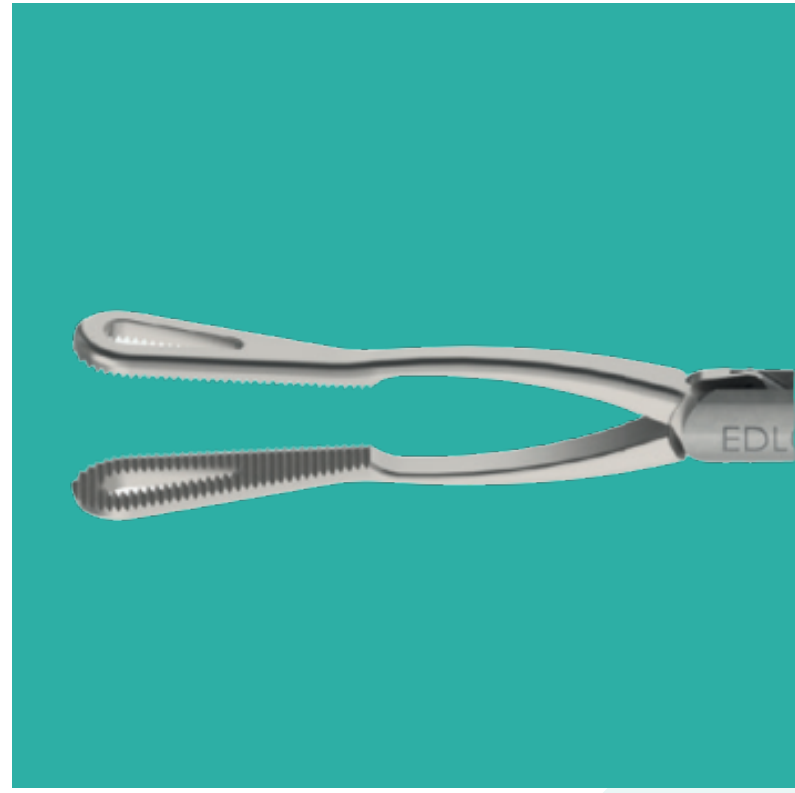

Pinça Atraumática p/ Grandes Órgãos Ø10mm

14-5143, 14-5144, 14-5145, 14-5146, 14-3043 e 14-3061

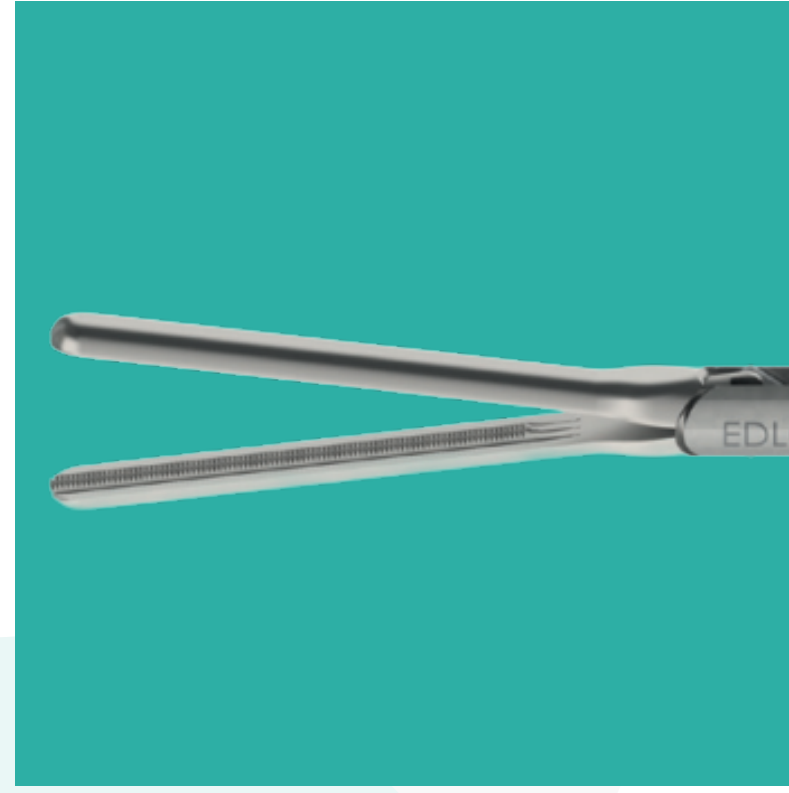

Pinça Atraumática Tipo de Bakey Boca 60mm Ø10mm

14-5147, 14-5148, 14-5149, 14-5150, 14-3042 e 14-3055

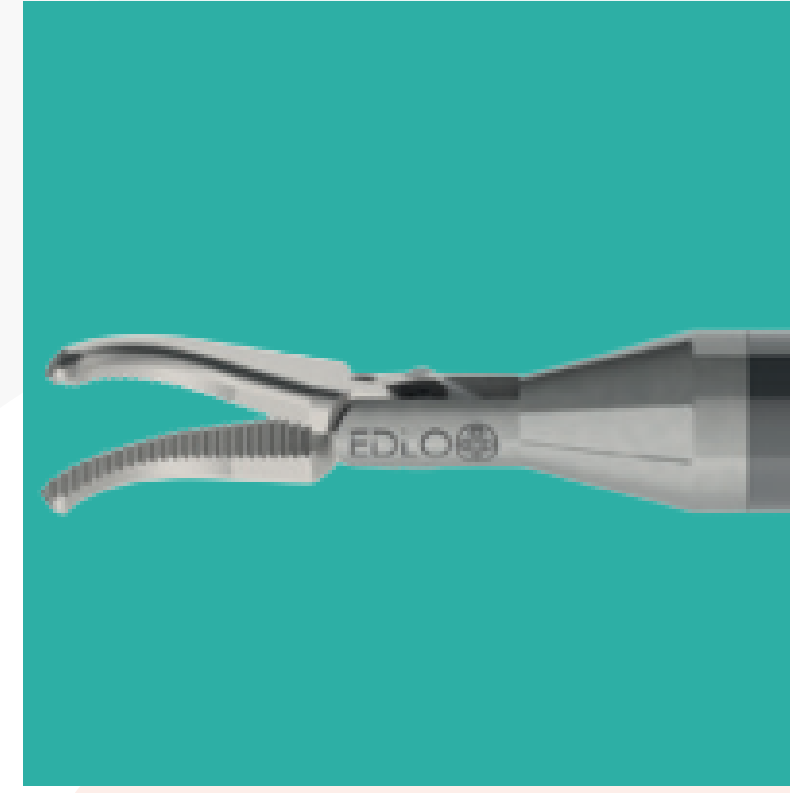

Pinça Maryland de Dissecção Ø10mm

14-5017, 14-5018, 14-1581 e 14-3025

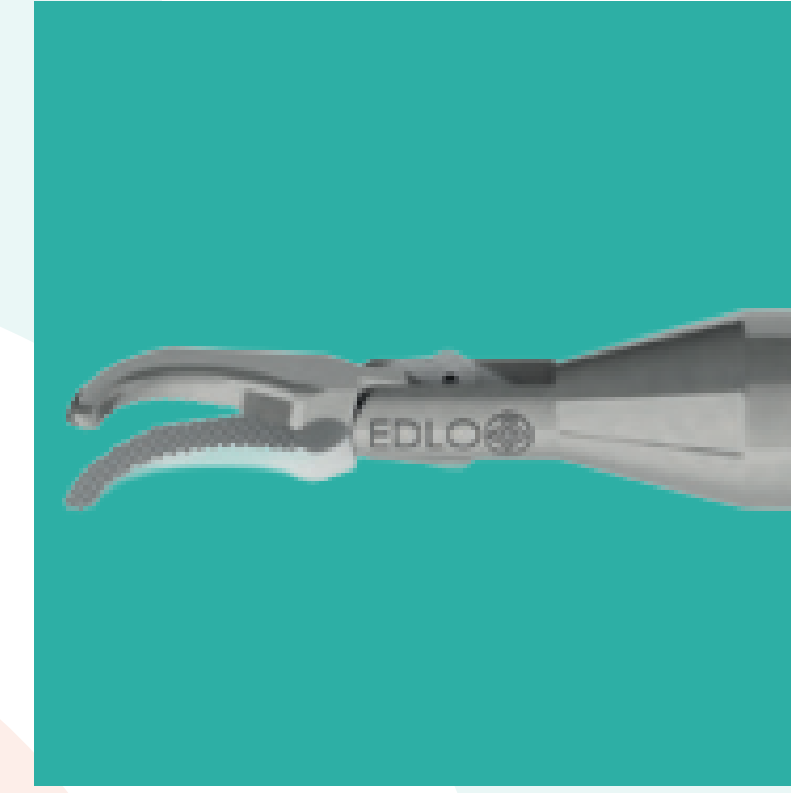

Pinça Mixer de Dissecção Ø10mm

14-5151, 14-5152, 14-1582 e 14-2823

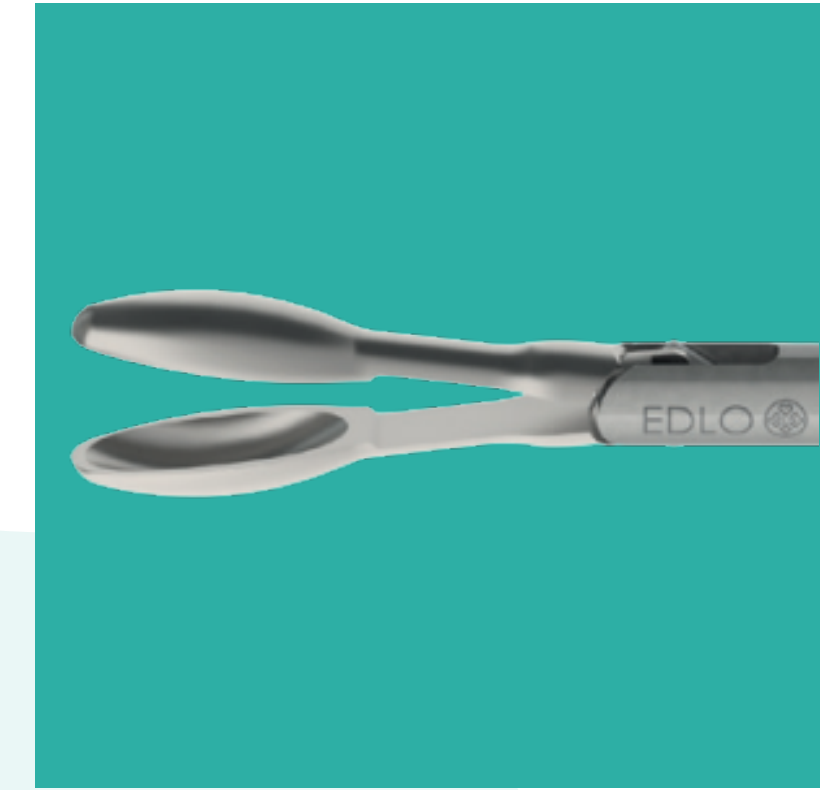

Pinça Winter Boca 60mm Ø10mm

14-5153, 14-5154, 14-3050 e 14-3306



Pinça Duval Ø10mm

14-5156, 14-5157, 14-2446 e 14-3316

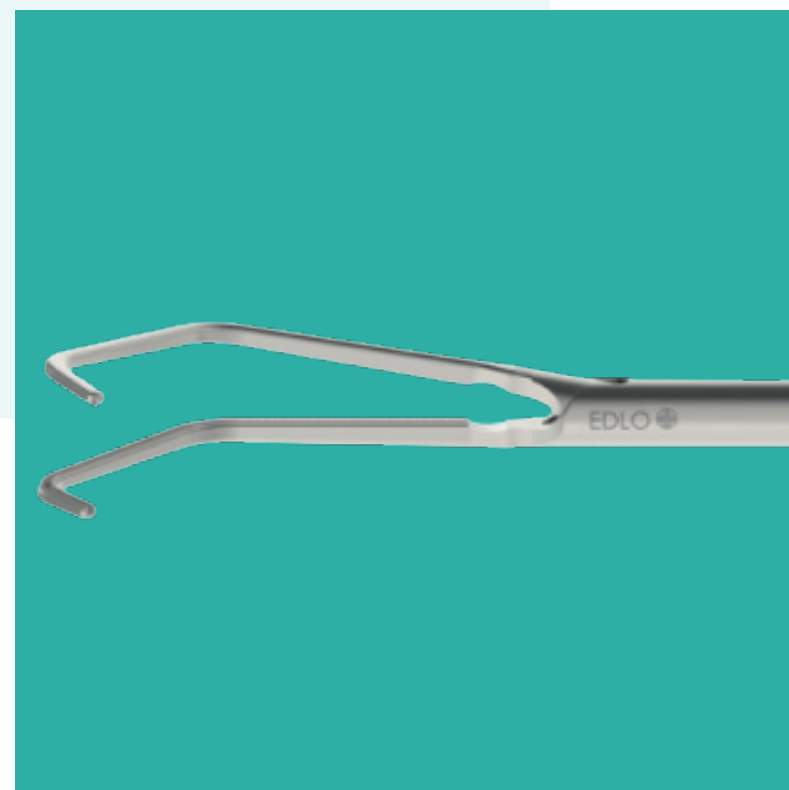

Pinça de Bakey / Satinsky Ø10mm

14-5183 e 14-3621

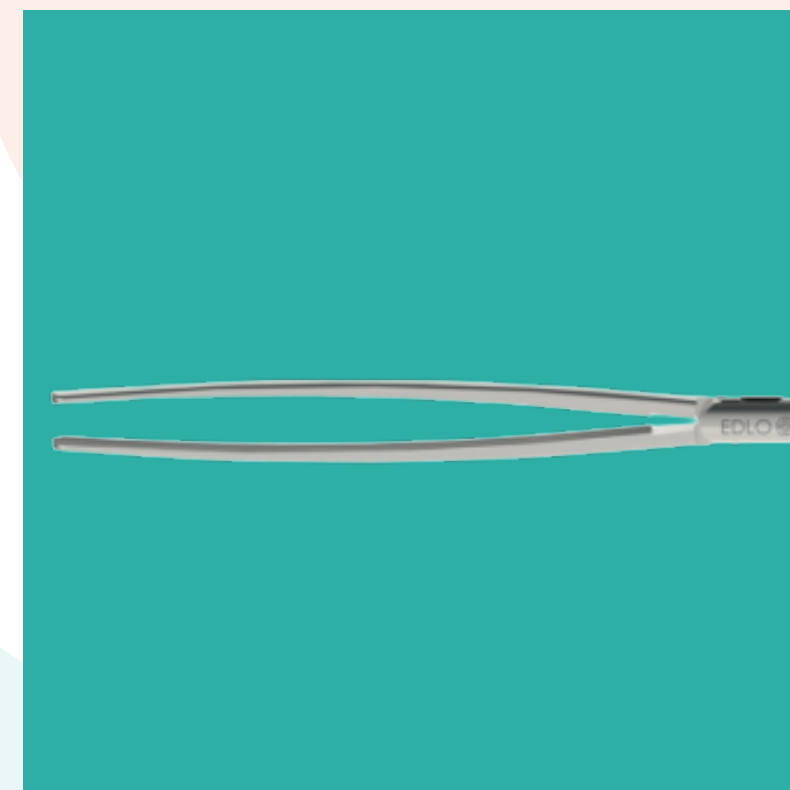

Pinça Simon Ø10mm

14-5158, 14-5159, 14-3319 e 14-3320



Pinça Satinsky Ø10mm

14-5155 e 14-3047

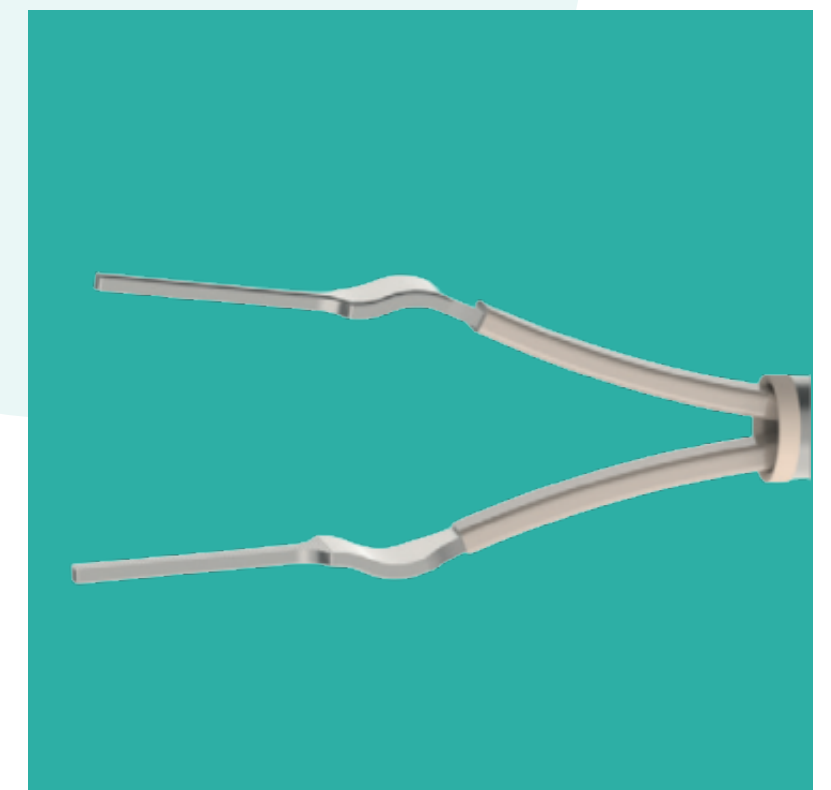

Pinça Bipolar Boca de 1mm e 3mm Serrilhada Ø5mm

14-2518, 14-2216, 14-2517, 14-2755, 14-2217 e 14-2756

PINÇAS

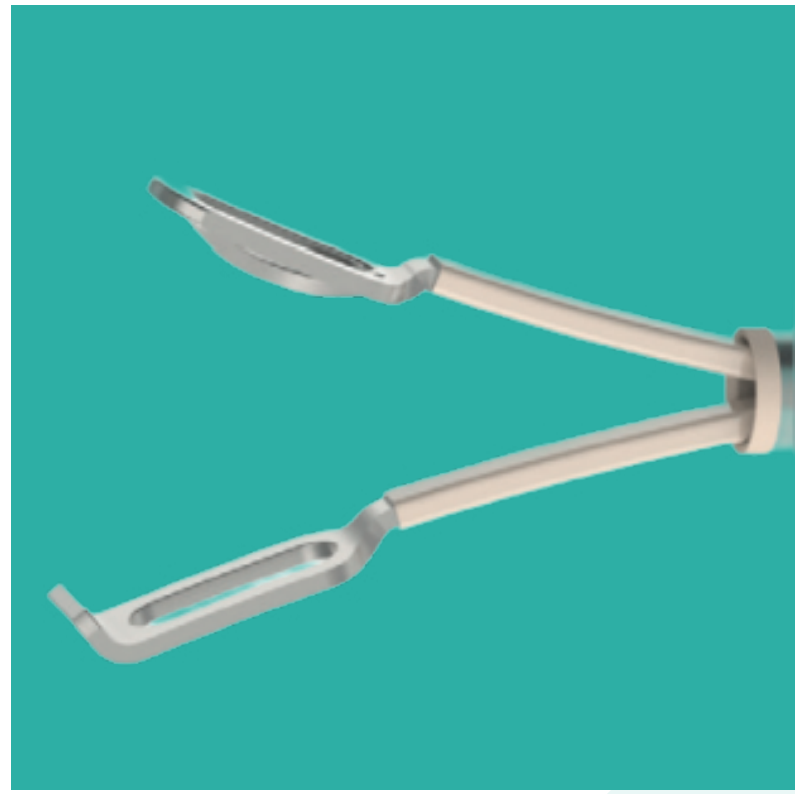

Pinça de Apreensão Bipolar Ø10mm

14-2516, 14-2716, 14-2218 e 14-2717



Pinça c/ Empunhadura em U Ø5mm Atraumática p/ Ginecologia

14-0954

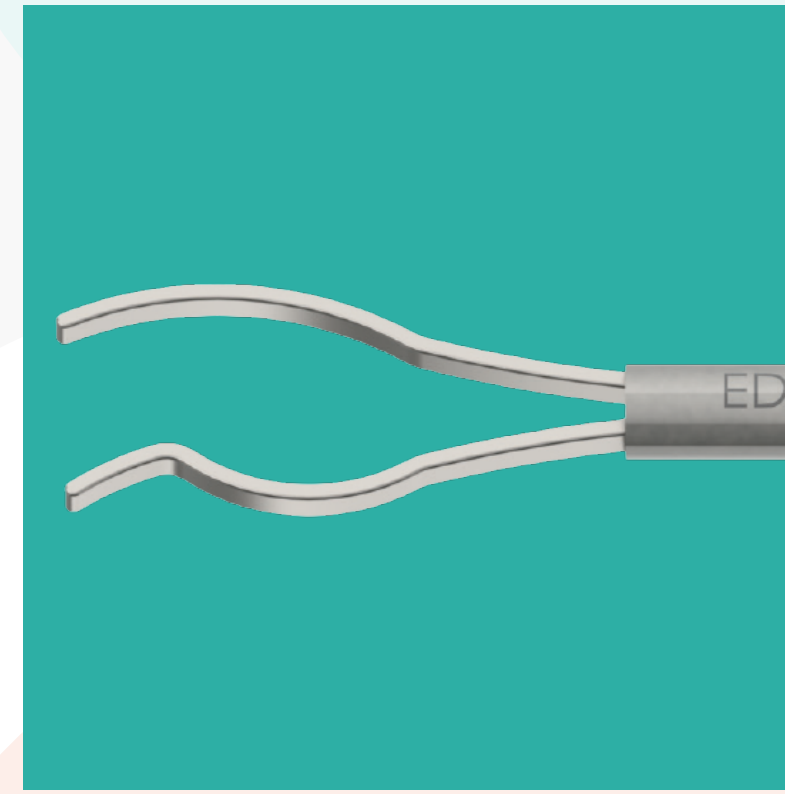

Pinça c/ Empunhadura em U Ø5mm p/ Trompas de Falópio

14-1082



Pinça c/ Empunhadura em U Ø5mm Atraumática p/ Apreensão do Tubo Digestivo e p/ Ginecologia Bowel

14-0955



Pinça Pozzi de Ø3mm, Ø5mm e Ø10mm

14-3221, 14-3129, 14-3222, 14-3128, 14-3217, 14-1172, 14-3219, 14-3218, 14-3038, 14-3220, 14-1173, 14-3205, 14-3041 e 14-3206



Pinça Dentada c/ Garra 2X3 Dentes de Ø5mm e Ø10mm

14-1430, 14-0979, 14-2820, 14-3054, 14-3039, 14-2821, 14-0980, 14-1467, 14-3040 e 14-3053



Cânulas

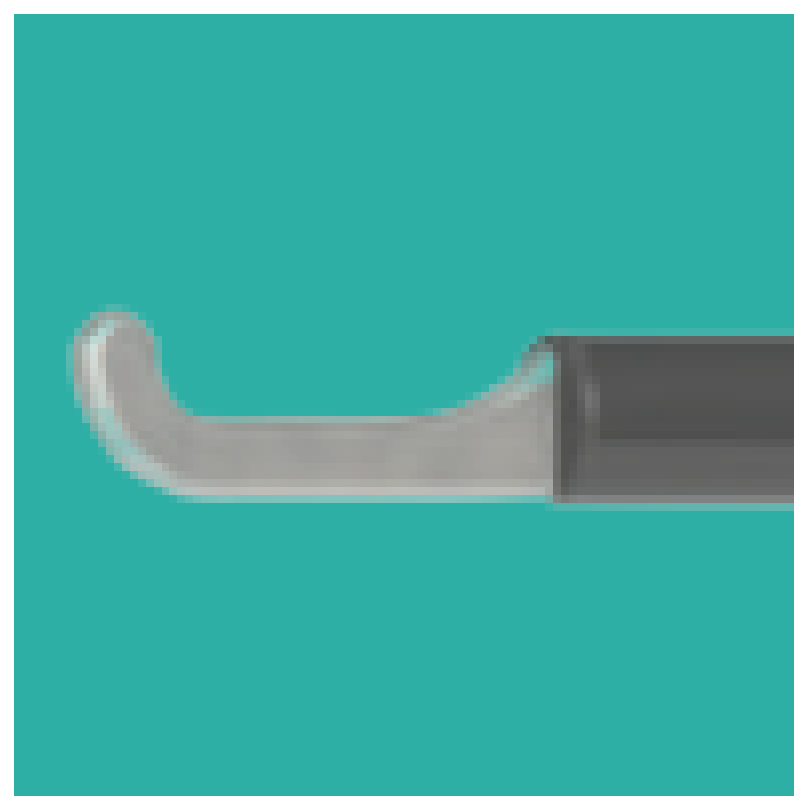

**Cânula de Dissecção
Ângulo Reto Ø3mm
e Ø5mm**

14-2249, 14-1531, 14-1424,
14-1059 e 14-1423

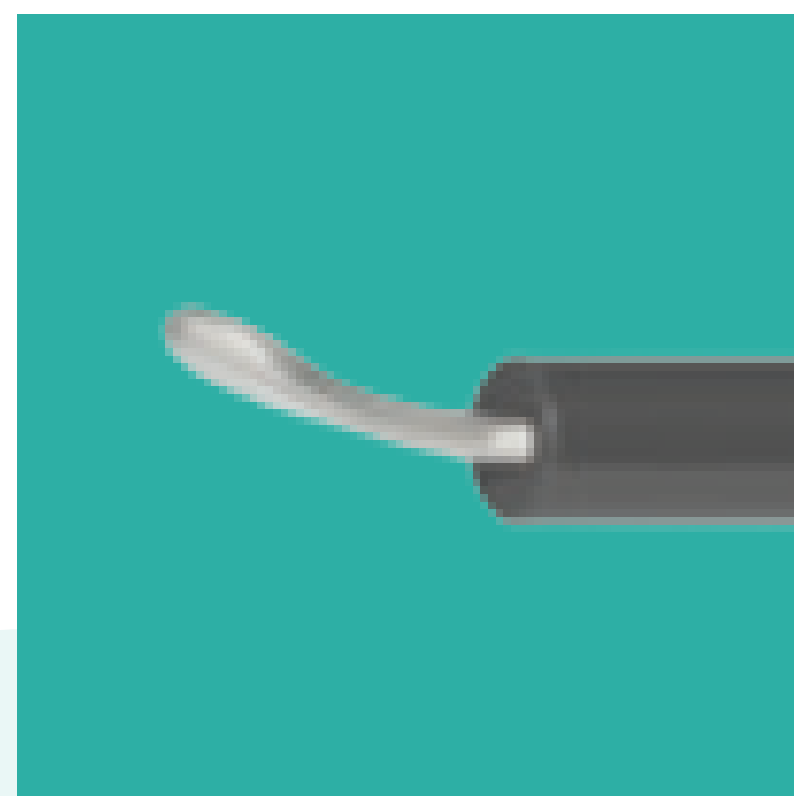

**Cânula de
Dissecção Espátula
Ø3mm e Ø5mm**

14-1530, 14-1421, 14-1057 e
14-2564

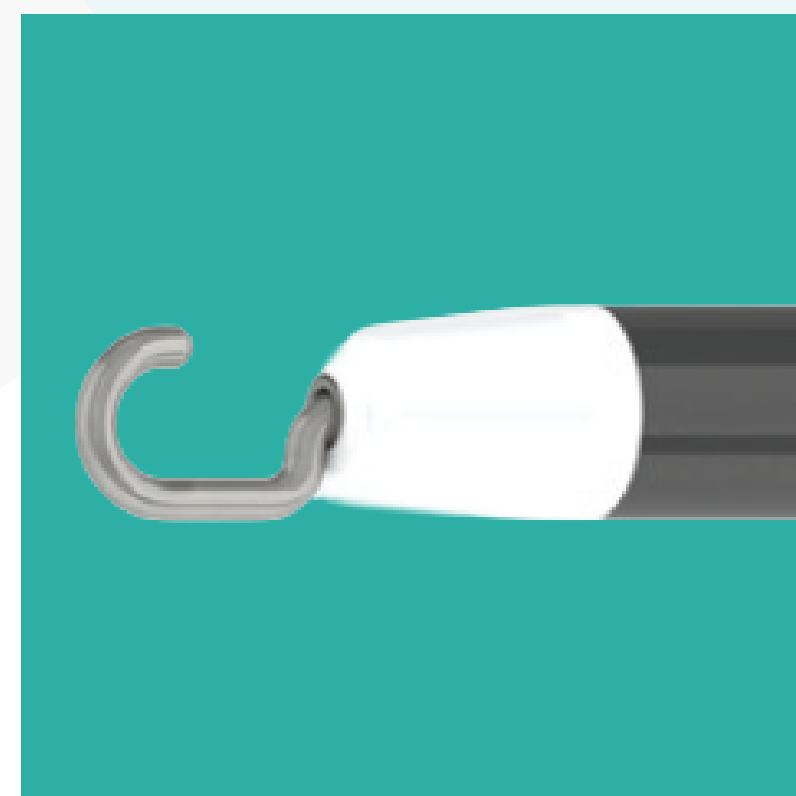

**Cânula de
Dissecção Gancho J
Ø5mm**

14-1422, 14-1058 e 14-3230

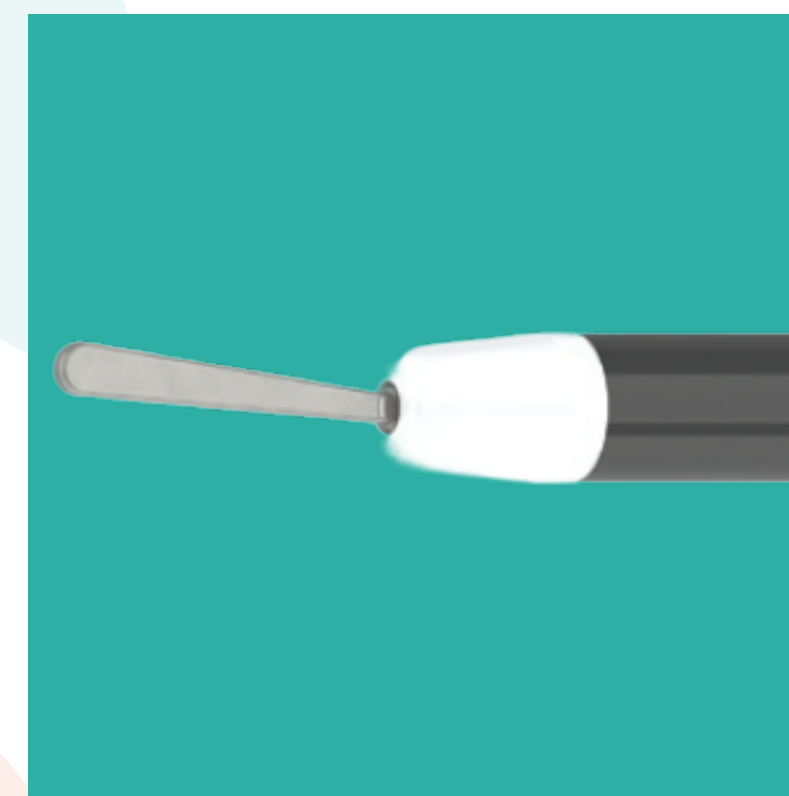

**Cânula de
Dissecção Espátula
Angulada Ø5mm**

14-2793 e 14-1121

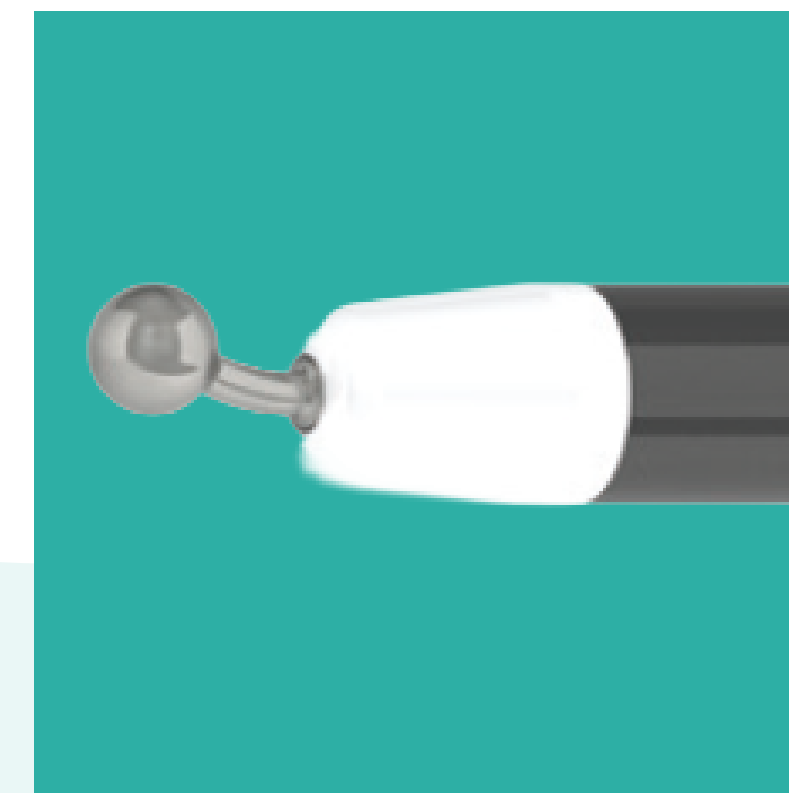

**Cânula de
Dissecção Esfera
Angulada Ø5mm**

14-1149

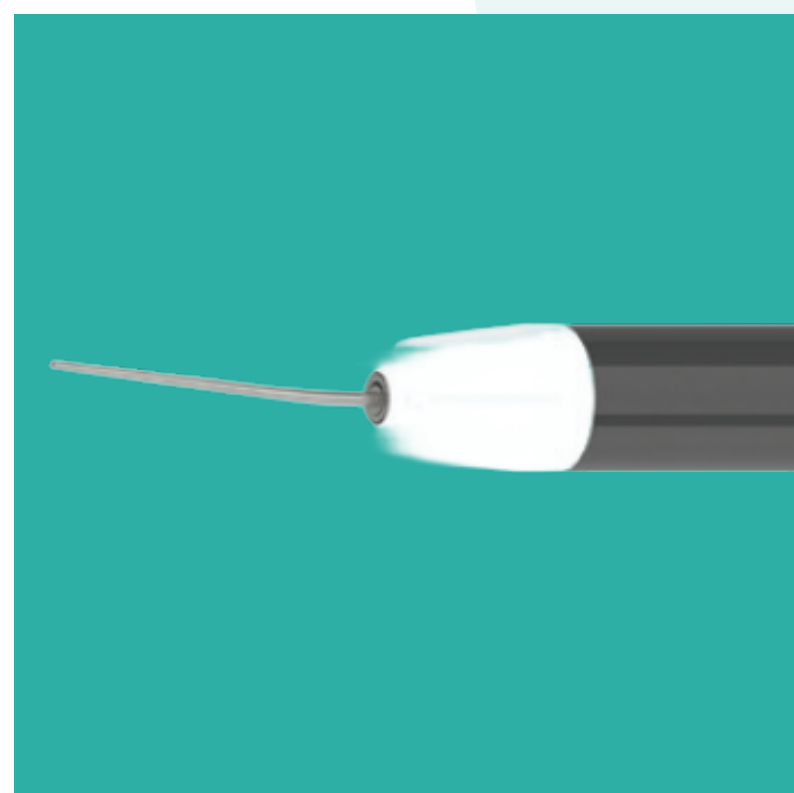

**Cânula de Dissecção
c/ Ponta em Agulha
Angulada Ø5mm**

14-1154

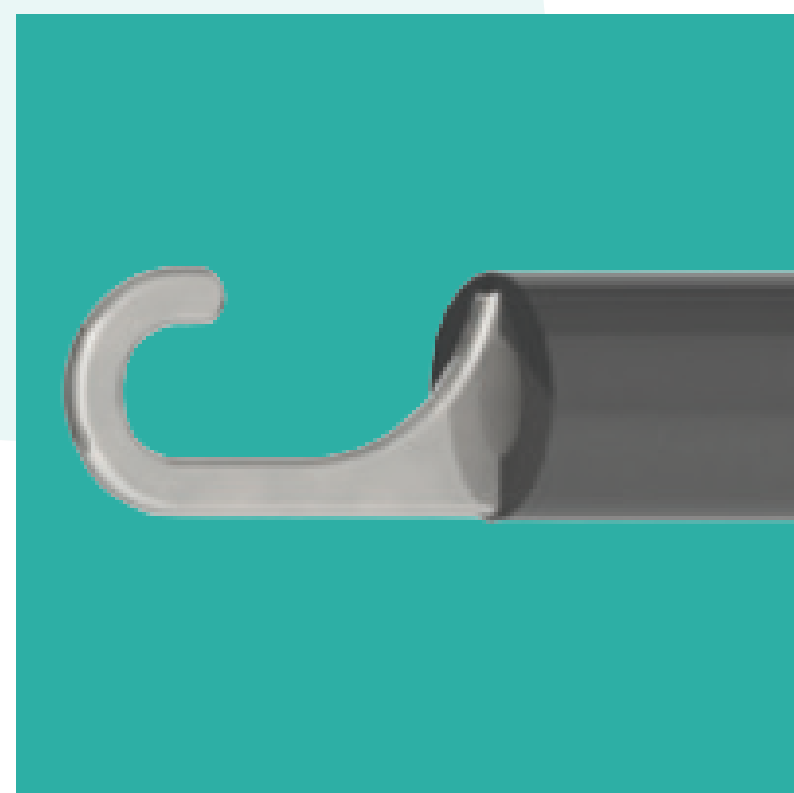

**Cânula de
Dissecção Gancho
J c/ Válvula Ø5mm**

14-1009

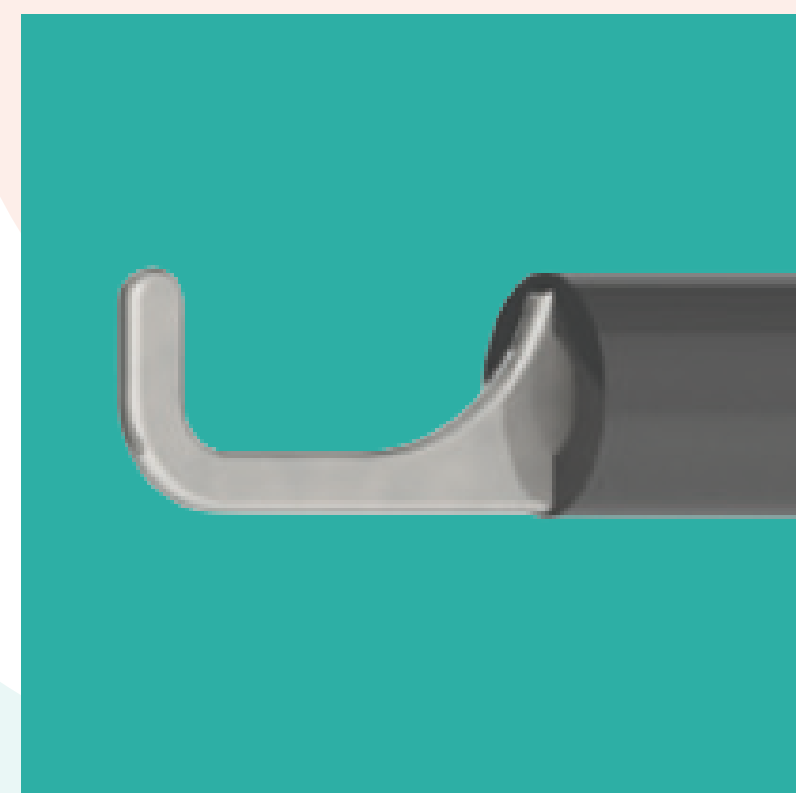

**Cânula de Dissecção
Ângulo Reto c/
Válvula Ø5mm**

14-1008

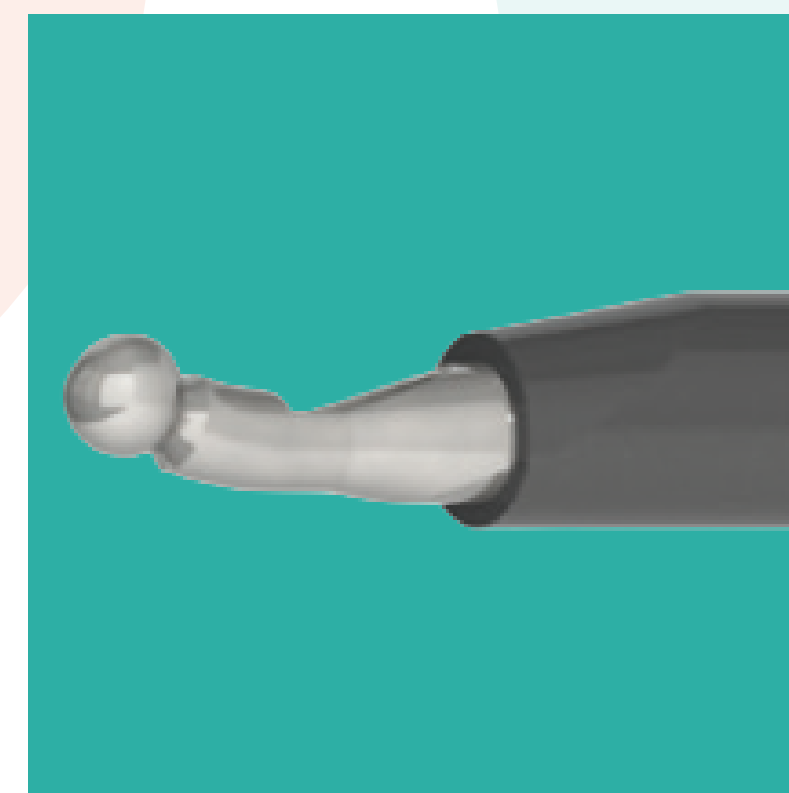

**Cânula de Dissecção
Esfera Angulada c/
Válvula Ø5mm**

14-1160

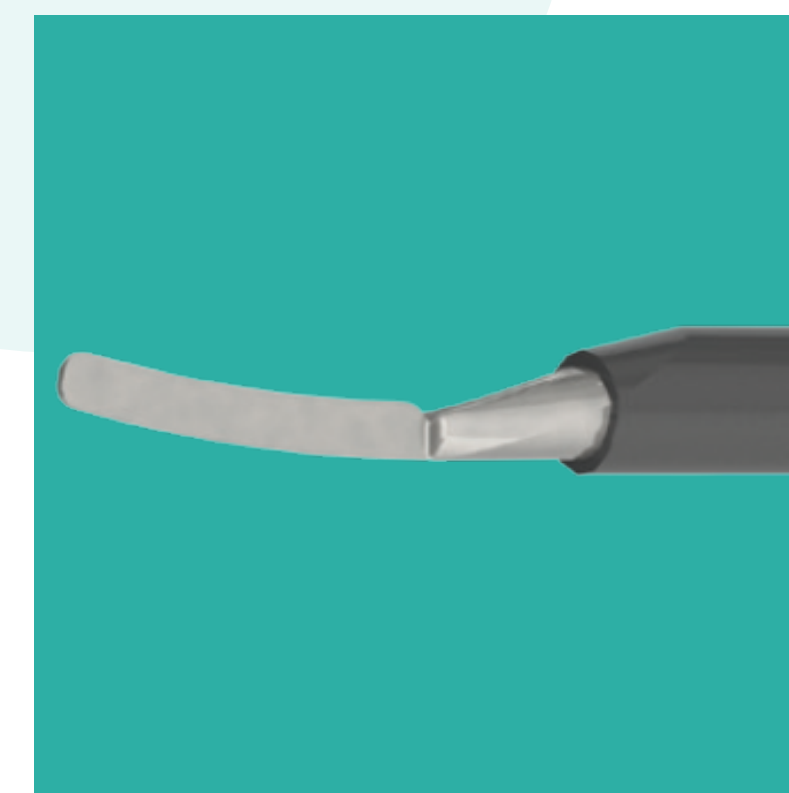

**Cânula de Dissecção
Espátula Angulada
c/ Válvula Ø5mm**

14-1161

CÂNULAS

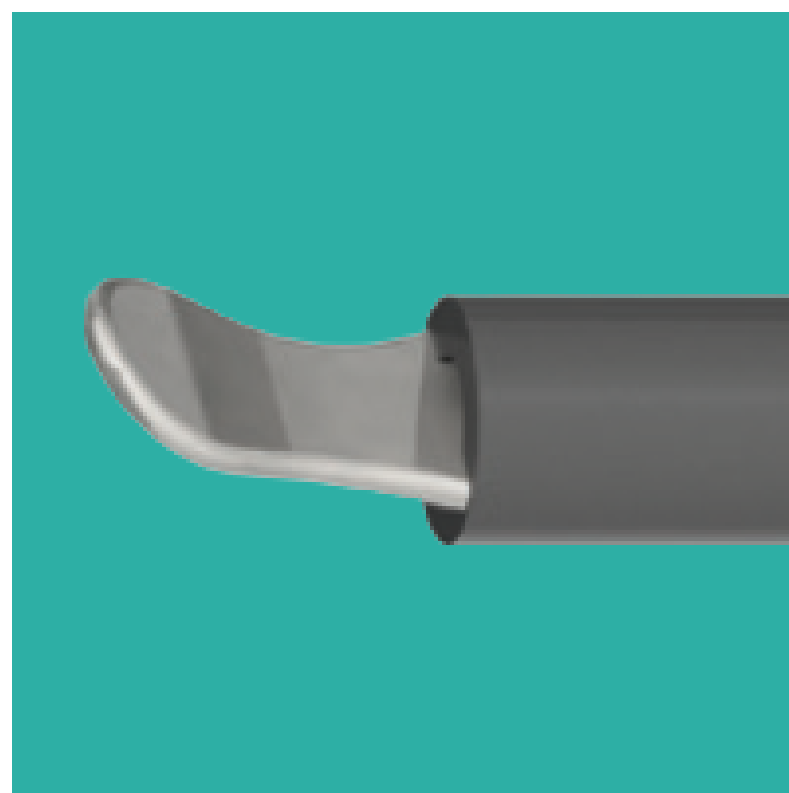

Cânula de Dissecção Espátula c/ Válvula Ø5mm
14-1007



Cânula p/ Fechamento de Aponeurose
14-0474



Cânula p/ Fechamento de Aponeurose Tipo Gancho
14-1137



Cânula p/ Pneumoperitônio de Veress Ø2,5mm
14-1400, 14-0970 e 14-0971



Cânula de Punção e Injeção Agulha de 0,8 Ø5mm
14-1457 e 14-0968



Cânula Colangiografia Ø5mm
14-0999



Cânula de Punção e Injeção Agulha 2,1 Ø5mm
14-3231 e 14-0969

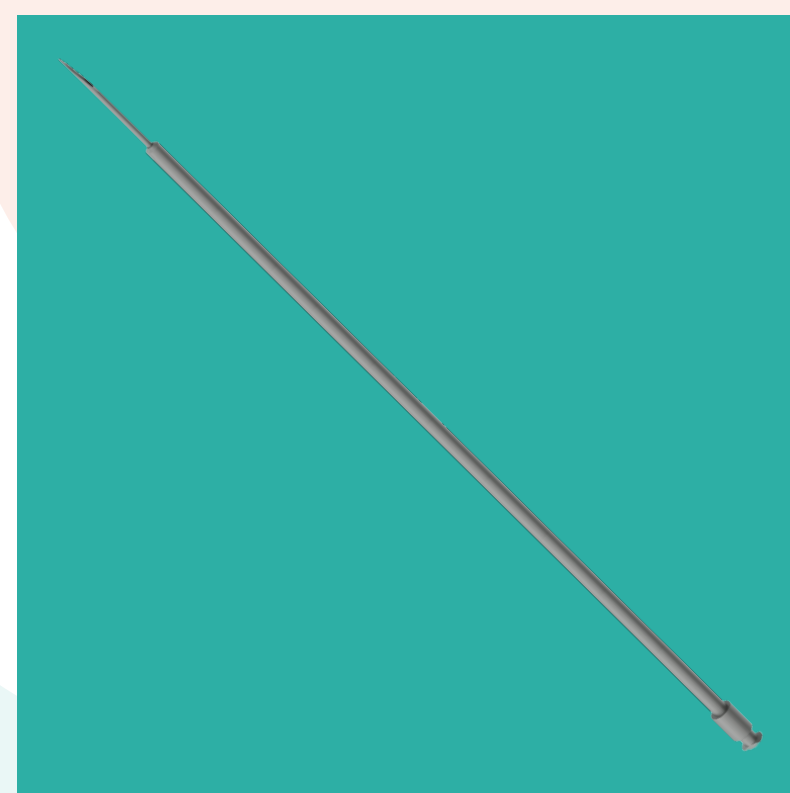

Cânula de Punção e Injeção Agulha 0,8 Ø3mm
14-3232 e 14-2430



Cânula Agulha Especial Suturas Edlo
14-2551, 14-2390, 14-2234, 14-2550, 14-2391 e 14-2373

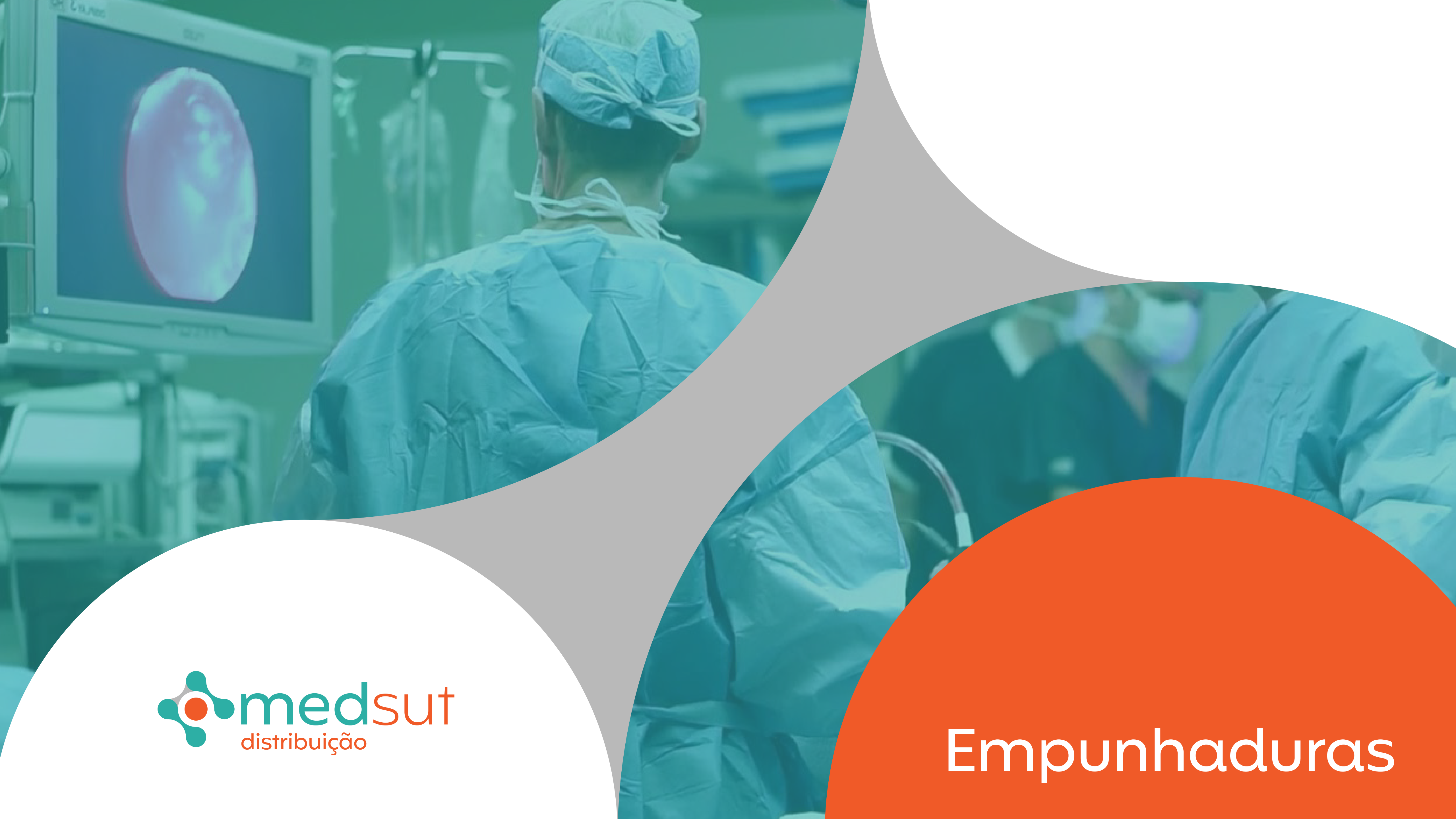

Empunhaduras

EMPUNHADURAS



Empunhadura Easy Light c/ Cremalheira
14-3200



Empunhadura Easy Light
14-3199

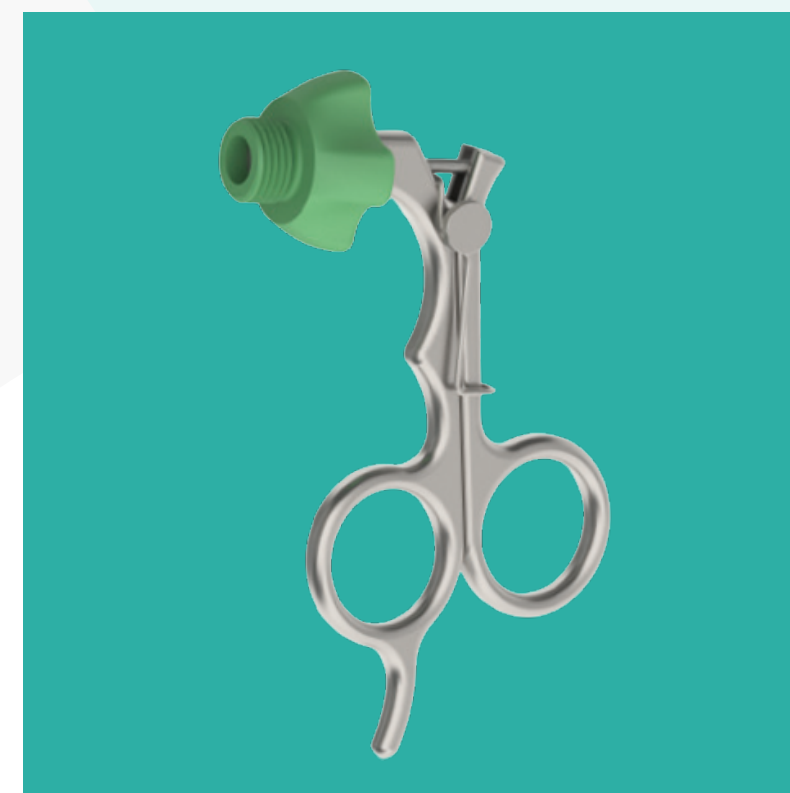

Empunhadura de Aço c/ Mola Reposicionadora
14-1115



Empunhadura Mathieu p/ Porta Agulhas
14-2380

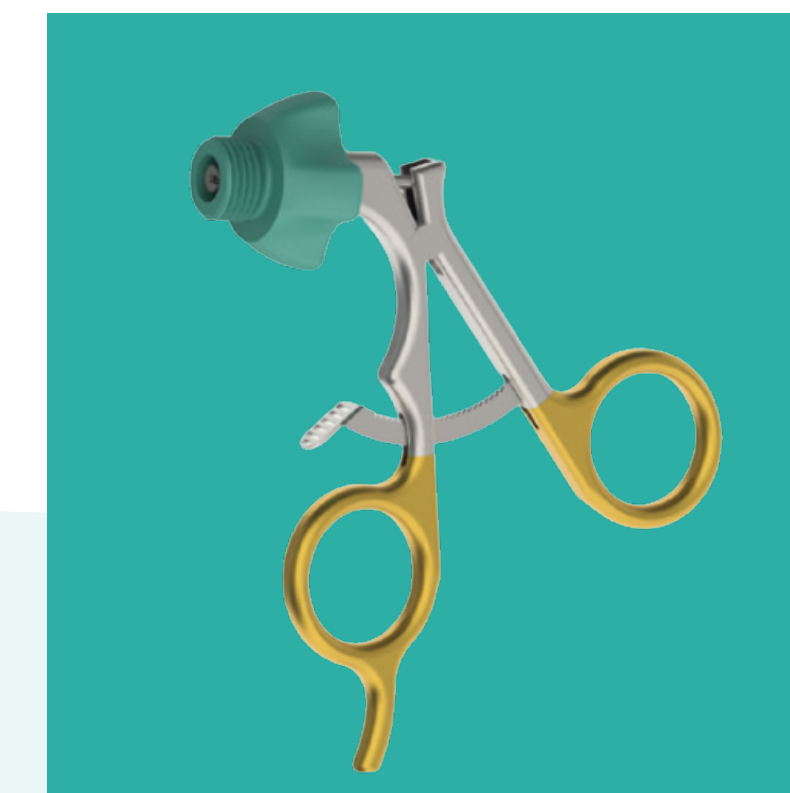

Empunhadura c/ Anéis Dourados
14-1119



Empunhadura Longitudinal de Aço c/ Anéis Dourados p/ Porta Agulhas
14-1122



Empunhadura p/ Aplicador de Clips 10mm e 12mm SLS Handle For SLS Clip
14-2214



Empunhadura Aplicador de Clips 5mm e 6,5mm
14-2209

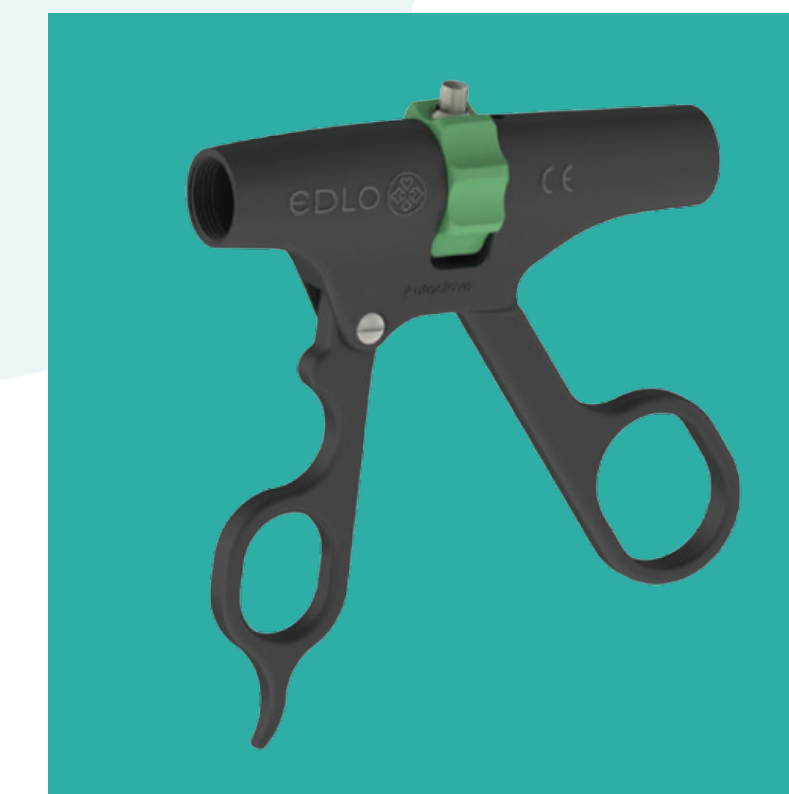

Empunhadura p/ Pinça Bipolar PPS
14-2519



Complementos

COMPLEMENTOS



Extrator Redutor
Ø10mm p/ Ø5mm
Diaf. Ø10mm X 11cm e
Ø10mm X 8,5cm
14-1060 e 14-1425

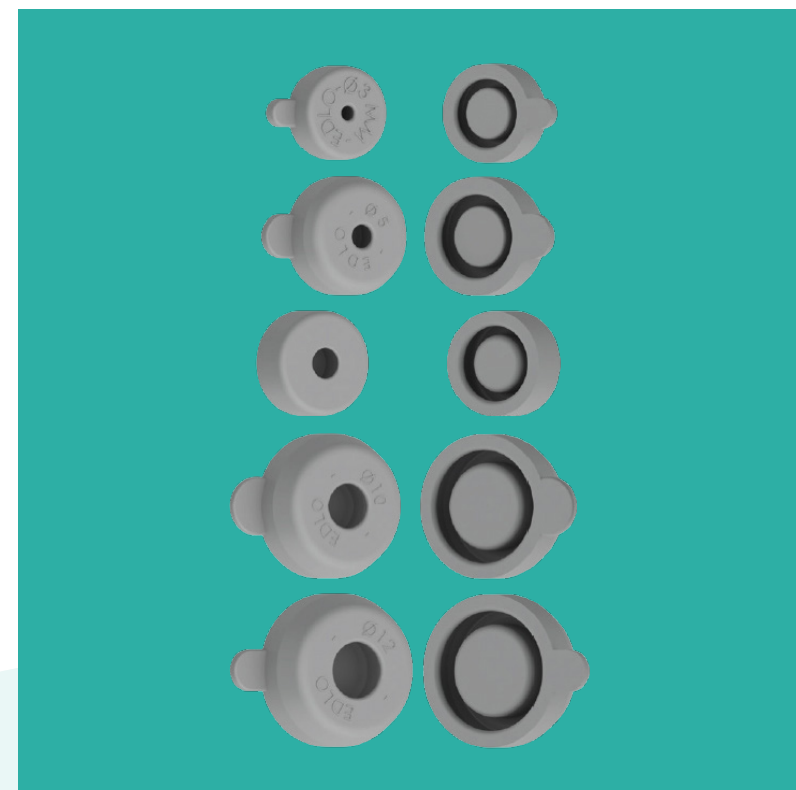

Redutor p/ Janela
de Ø5mm p/ Ø3mm,
Ø10mm p/ Ø5mm e
Ø12mm p/ Ø5mm
14-1540, 14-1043 e 14-1043



Redutor Acoplar Bainha
Tipo Diafragma
Ø10mm p/ Ø5mm e
Ø12mm p/ Ø5mm
14-2876 e 14-2875



Redutor Acoplar
Bainha Tipo Janela
Ø10mm p/ Ø5mm e
Ø12mm p/ Ø5mm
14-1205 e 14-0477

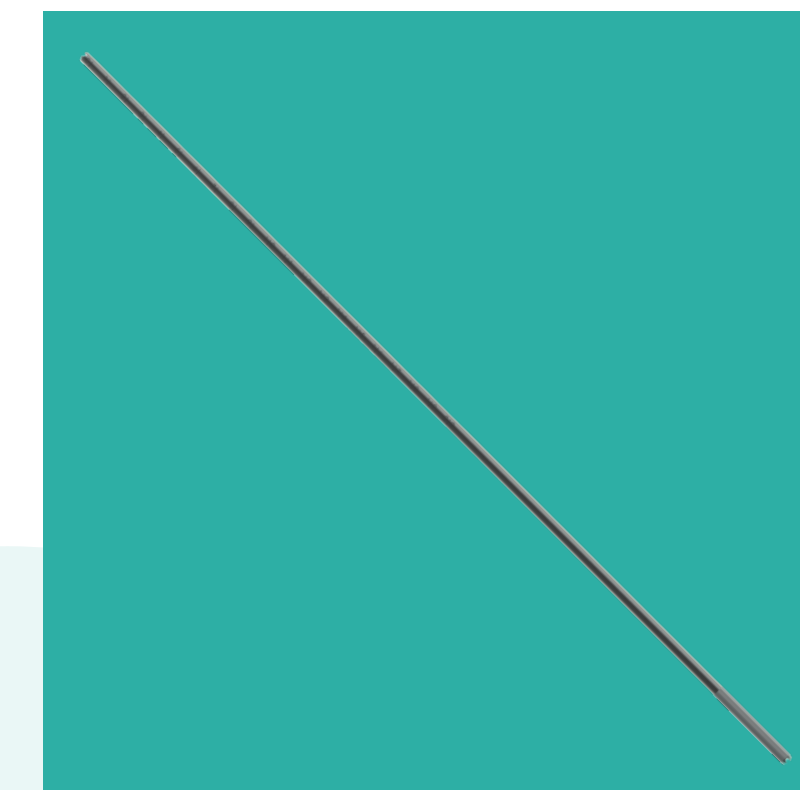

Sonda Apalpadora
Graduada Ø5mm X
36cm e Ø5mm X 42cm
14-0985 e 14-2809



Saca Mioma
Ø5mm X 36cm e
Ø10mm X 36cm
14-1000 e 14-1001

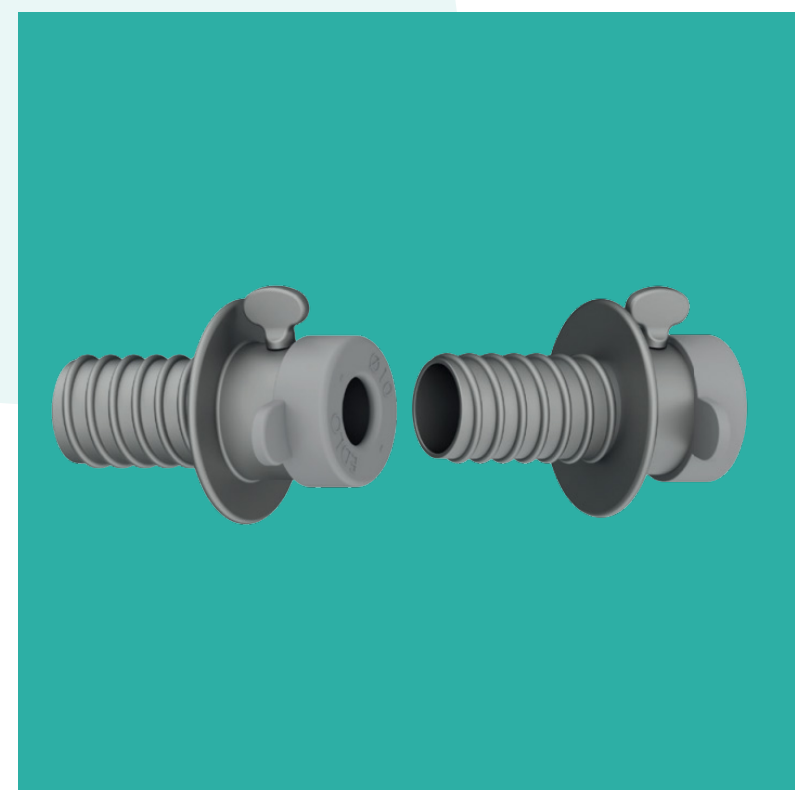

Limitador Bainha
Ø5mm e Ø10mm de
Trocarte Rosca
14-1037 e 14-1038

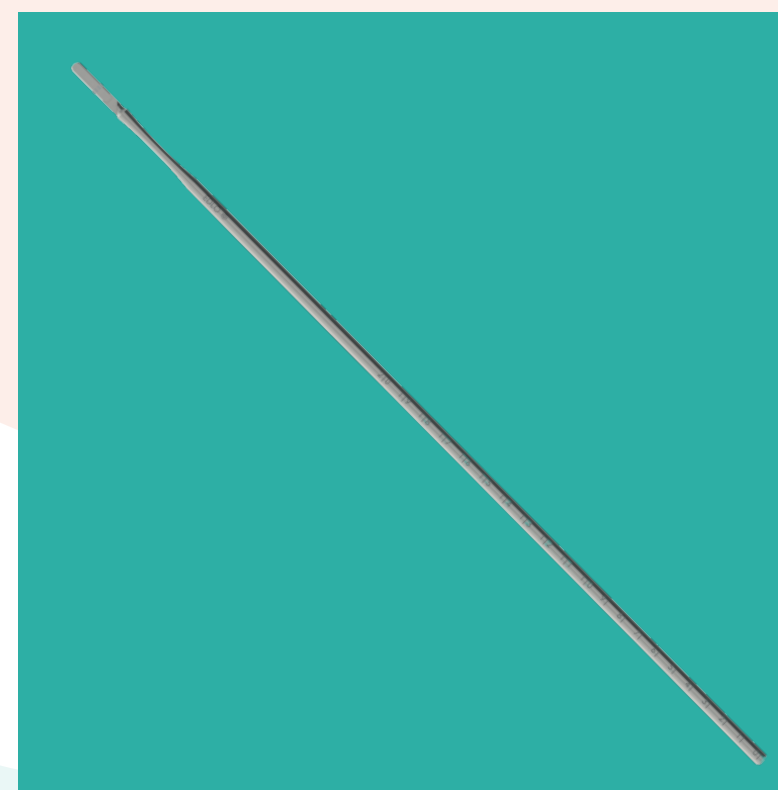

Bastão de Ueno Ø5mm X 36cm
(Cabo de Bisturi + Empurrador
de Nó + Sonda Apalpadora
Graduada)
14-1152

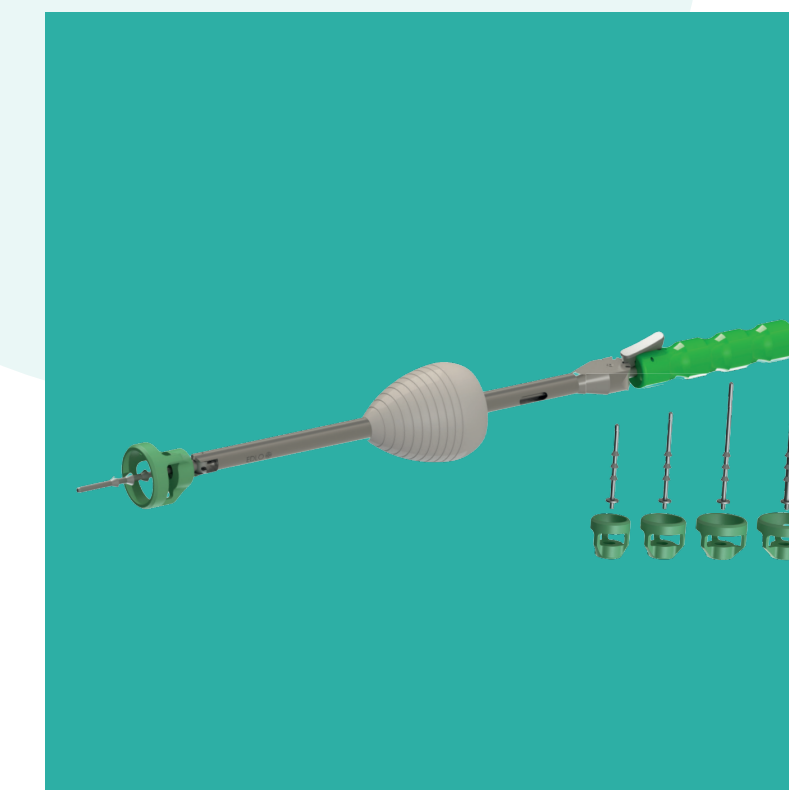

Manipulador e
Extrator Uterino Móvel
c/ 4 Ponteiras e 4
Acopladores Uterinos
14-1629

COMPLEMENTOS



Manipulador Uterino c/ Cânula de Cromotubagem e Pinça Pozzi 25cm
14-1062

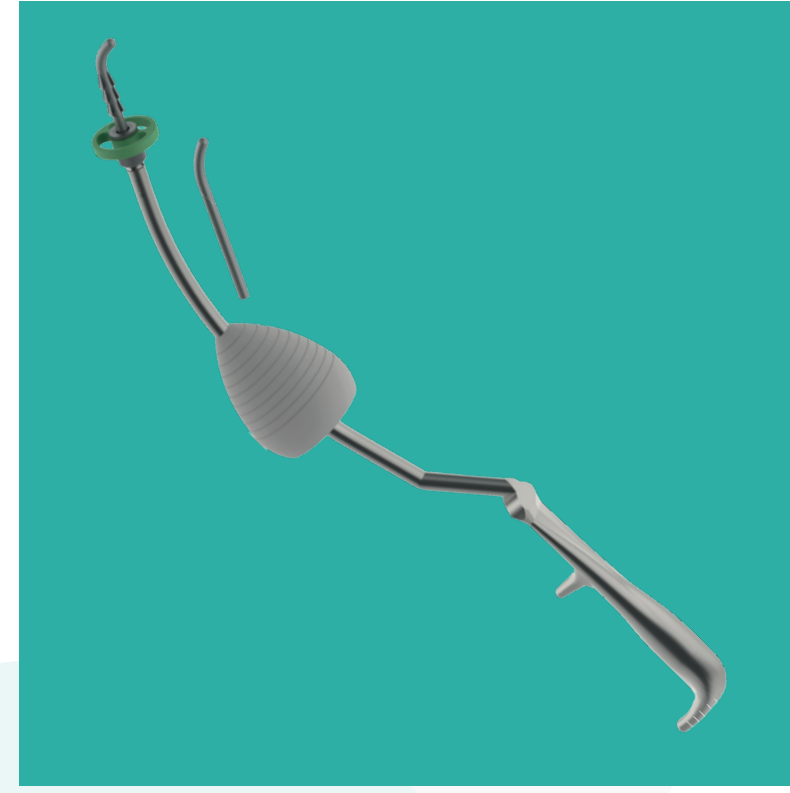

Extrator Uterino Gomes da Silveira
14-1595



Afastador Articulado Ø5mm X 36cm e Ø10mm X 36cm
14-1035 e 14-1036

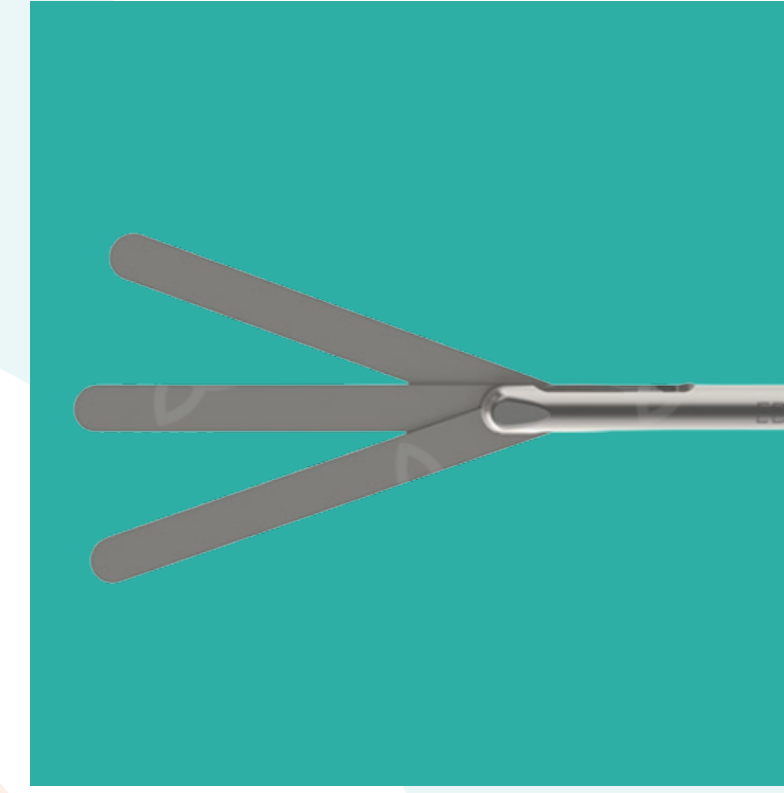

Afastador Articulado Flexível 3 Lâminas Ø5mm X 36cm
14-1535

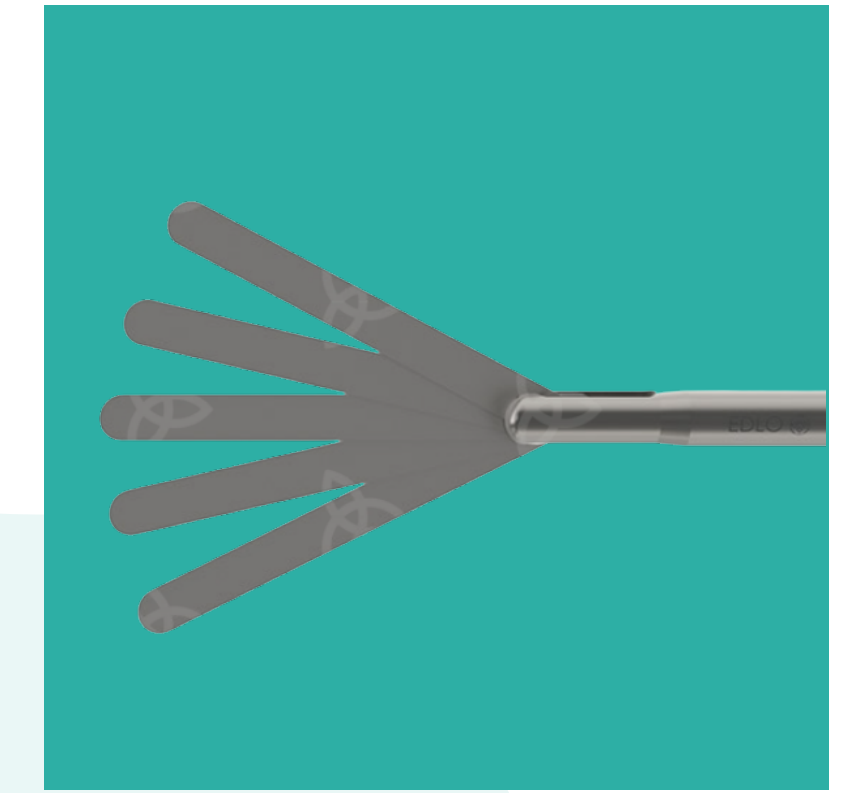

Afastador Articulado Flexível 5 Lâminas Ø10mm X 36cm
14-1534



Afastador Flex p/ Circundar Esôfago Ø5mm X 45cm
14-2800

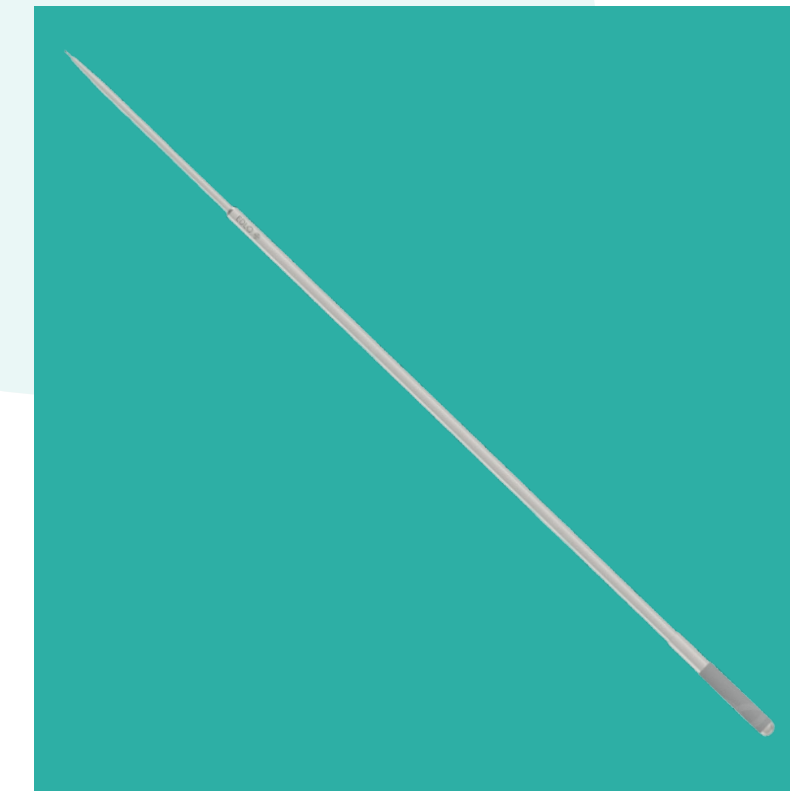

Empurrador de Nó Ø5mm X 36cm
14-1004

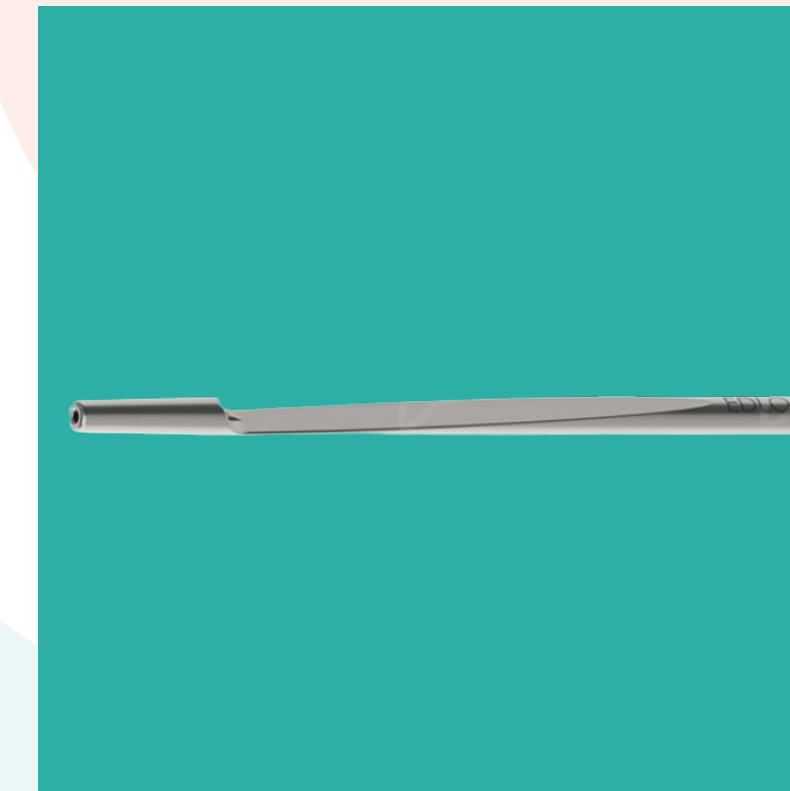

Empurrador de Nó Cambiaghi Ø3mm X 36cm (Aplicador Endoligadura)
14-2298

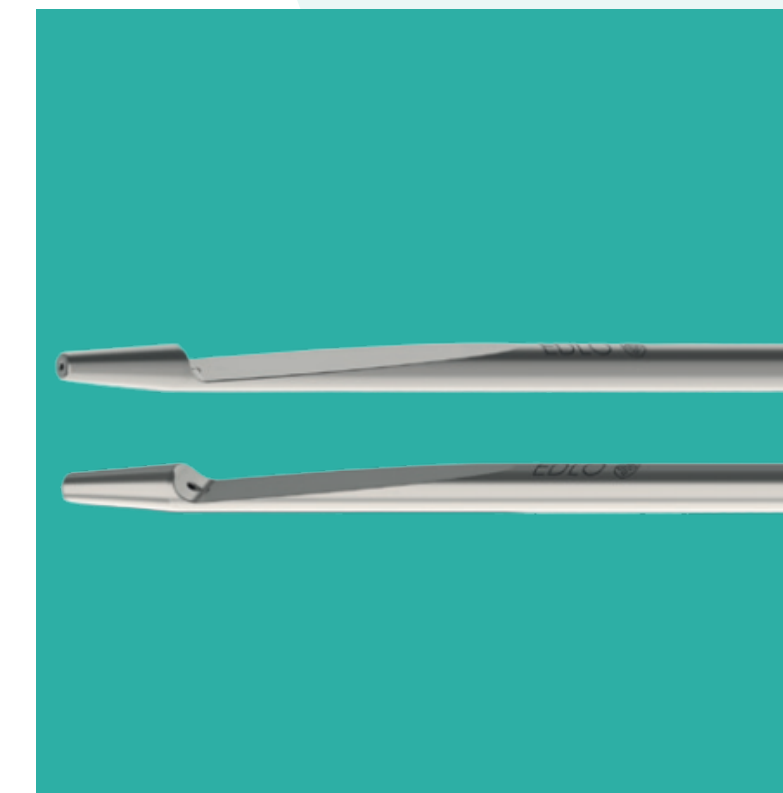

Empurrador de Nó Cambiaghi Ø5mm X 36cm Fio 0,8mm (Aplicador Endoligadura)
14-1095

COMPLEMENTOS

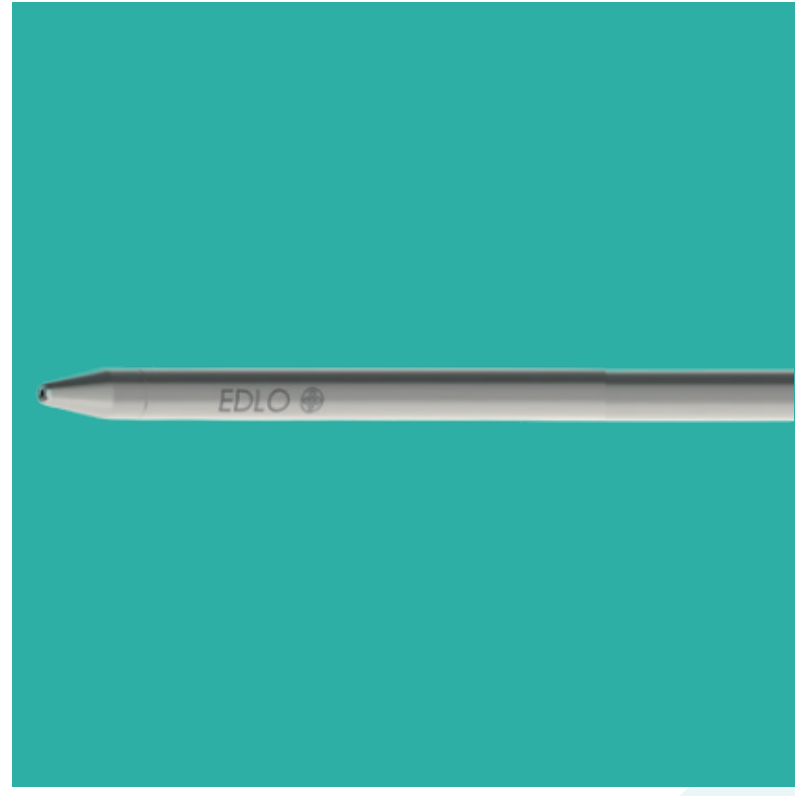

**Empurrador de Nó
Endoloop**
Ø5mm X 30cm
14-1402

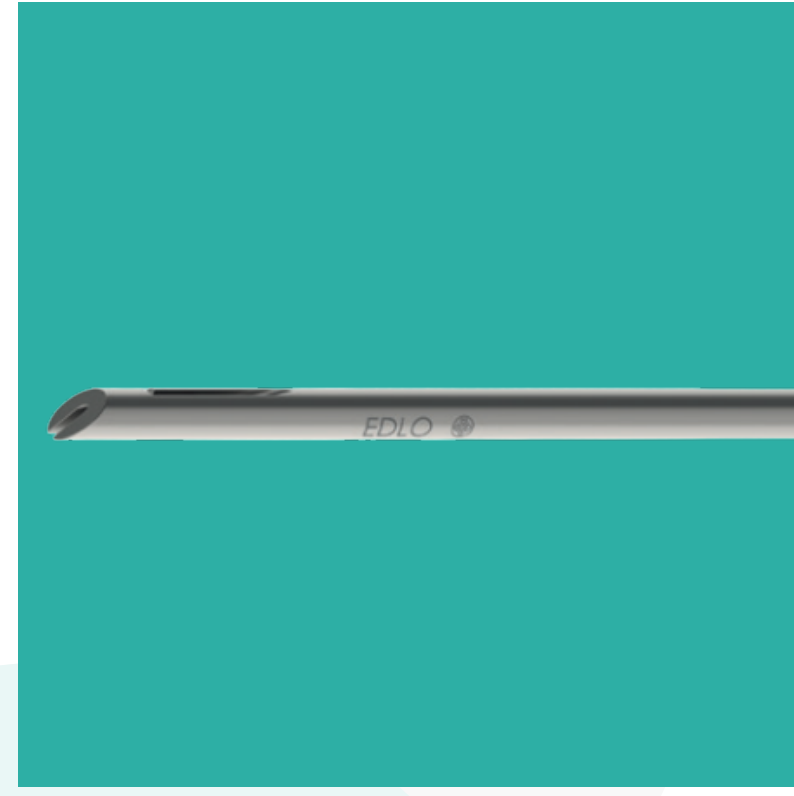

**Empurrador de Nó
Angulado**
Ø5mm X 33cm
14-1538



Vedantes

VEDANTES

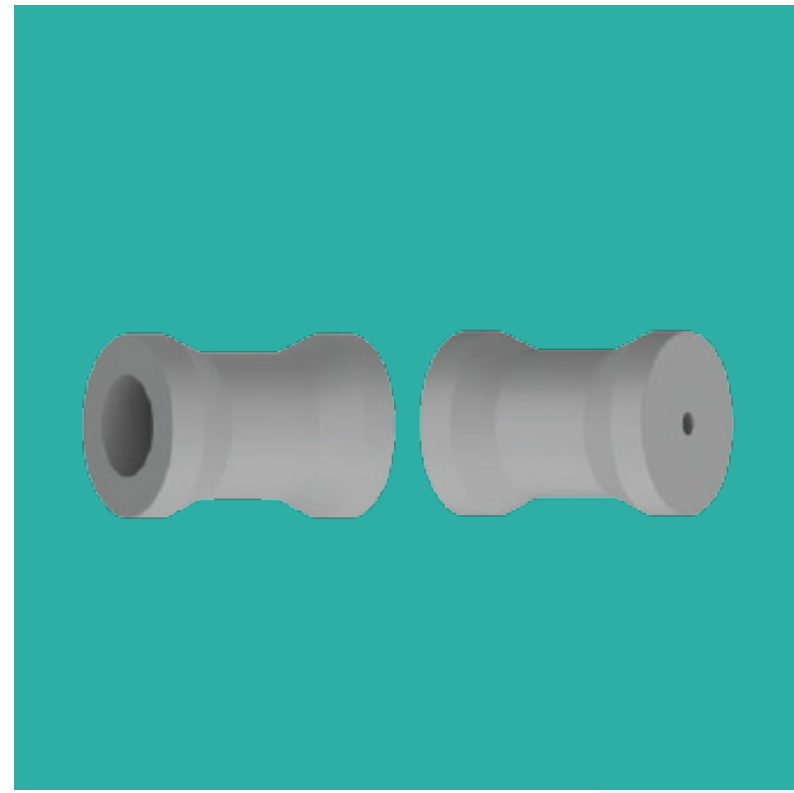

**Vedante Tipo Carretel p/
Pinça c/ Empunhadura
em U**

14-0944

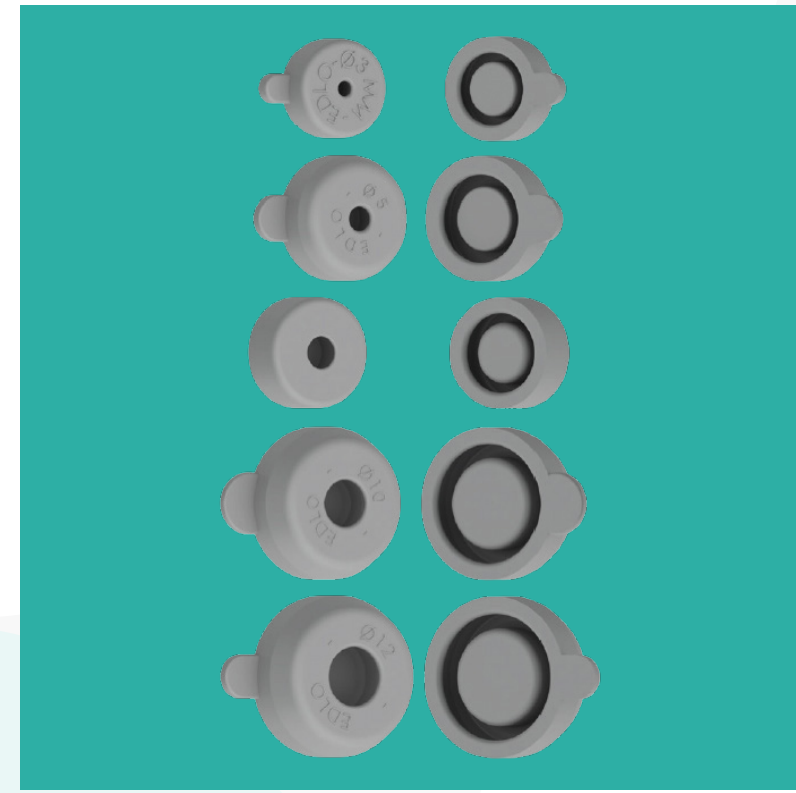

**Vedante p/ Bainha Tipo
Diafragma Ø3mm, Ø5mm,
Ø6,5mm, Ø10mm e Ø12mm**

14-1540, 14-1041, 14-1592, 14-1042 e
14-0478

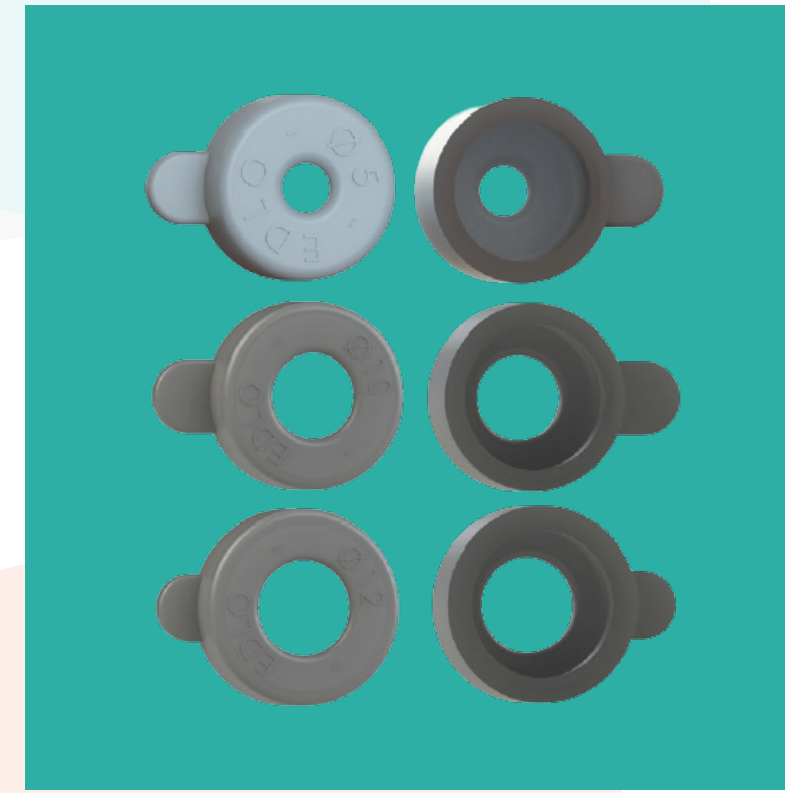

**Kit Vedante Tipo Copo
Bainha Janelas Ø5mm,
Ø10mm e Ø12mm (Ext.)**

14-1043, 14-1044 e 14-2126

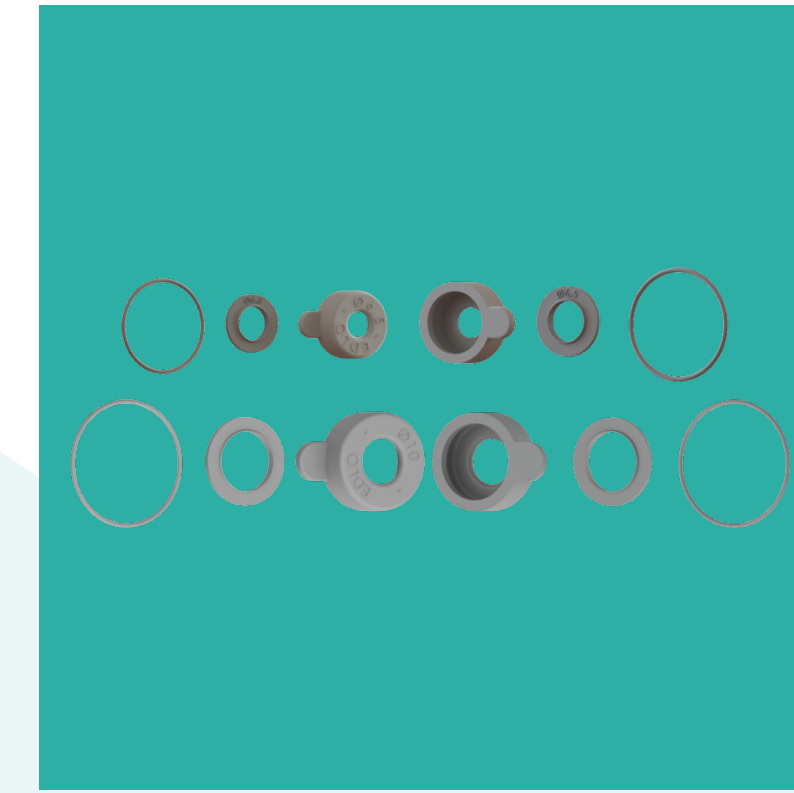

**Kit Vedante p/ Bainha Tipo
Janela Ø5mm, Ø6,5mm,
Ø10mm, Ø12mm (Ext. / Int.)**

14-3233, 14-3238, 14-3234 e 14-3235

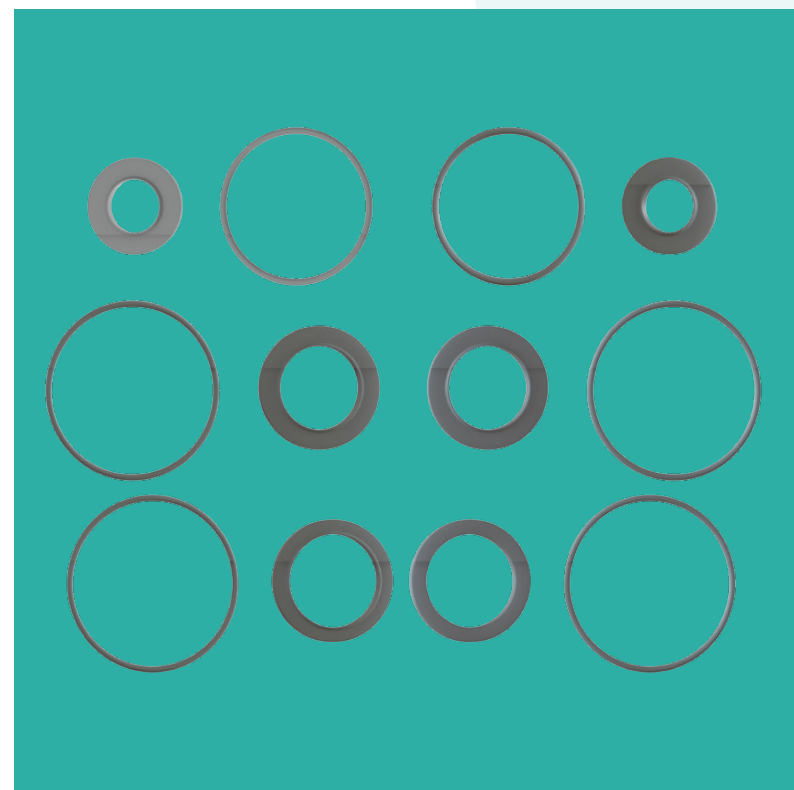

**Kit Vedante Interno
Bainha Janelas Ø5mm,
Ø10mm e Ø12mm**

14-1209, 14-1206 e 14-2007

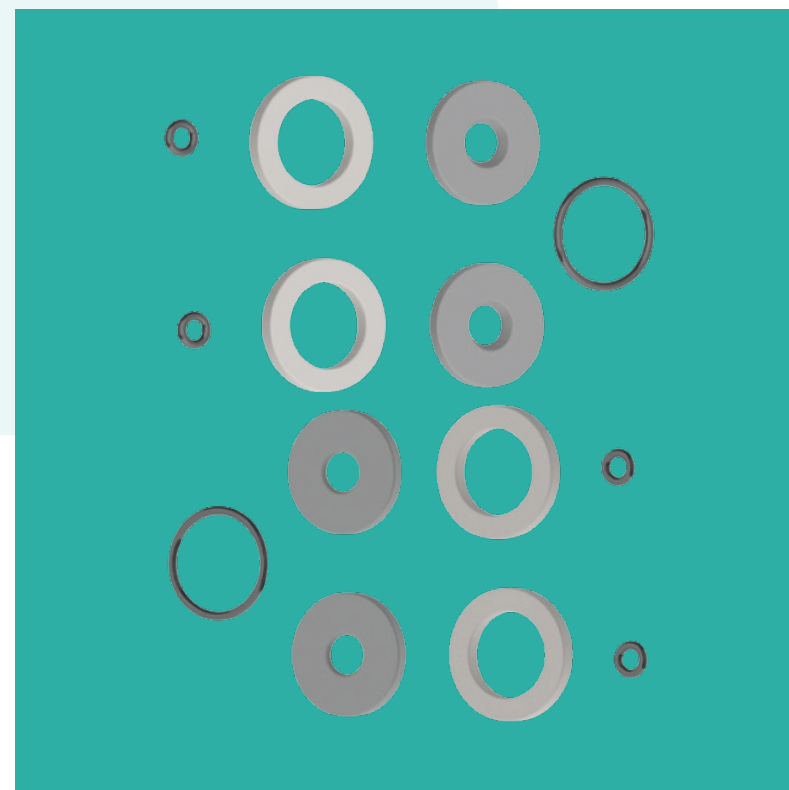

**Vedante Interno p/
Válvula p/ Aspiração
e Irrigação**

14-1627



Caixas Cirúrgicas



Caixa Perfurada
52cm X 28cm X 09cm
10-3156

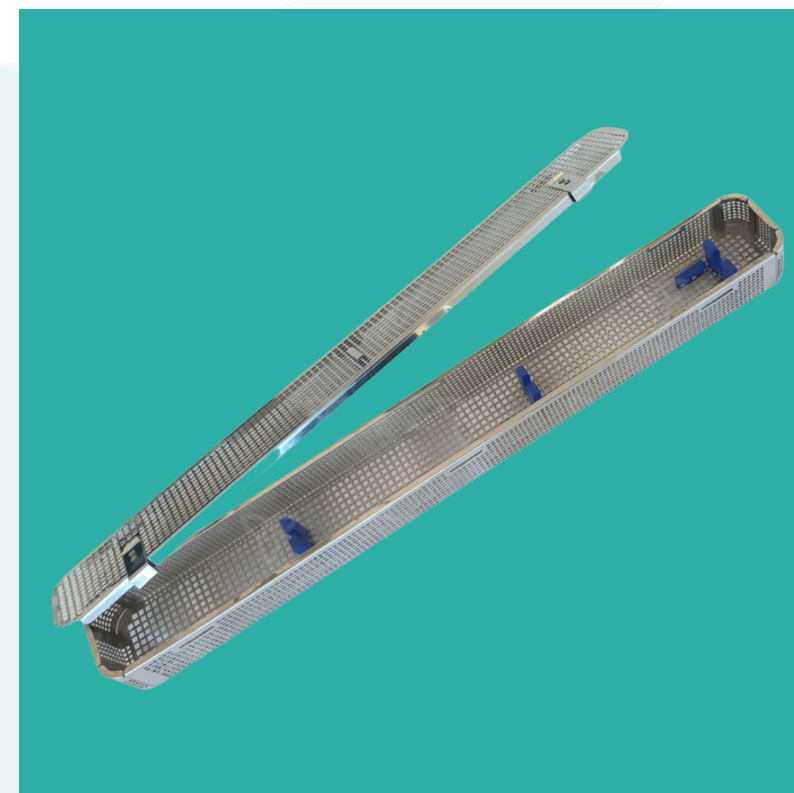

Cesto p/ Endoscópios
2mm, 2,9mm, 3mm,
4mm, 5mm E 10mm
10-3631



Cesto p/
Endoscópio 4mm
Artrosopia
10-3630

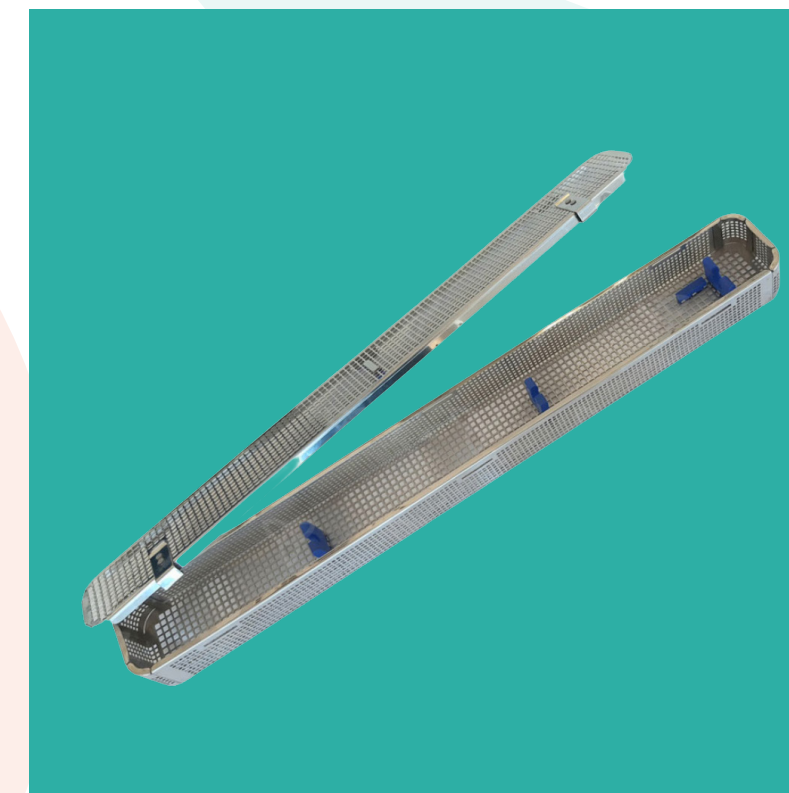

Cesto p/ Uretero
Renoscópio
10-3632



Caixa p/
Nefroscópio 45°
10-3633



Aspiradores



**Válvula p/ Tubo de
Aspiração e
Irrigação**

14-1626



**Cânula de Aspiração
e Irrigação Ø3mm,
Ø5mm e Ø10mm**

14-2313, 14-2327, 14-1063,
14-2416, 14-1448, 14-1064 e
14-2653



**Cânula de Aspiração e
Irrigação Hidrodissecção
Pta. Conf. Ø5mm**

14-1449 e 14-1065



**Cânula de Aspiração
e Irrigação Ponta
Agulha 2mm Ø5mm**

14-1450 e 14-1066



**Cânula de Aspiração
e Irrigação Duas
Válvulas Ø5mm**

14-1011



Aplicadores de Clip

APLICADORES DE CLIP



**Empunhaduras p/
Aplicadores de Clip
Ø5mm e Ø6,5mm**
14-2209

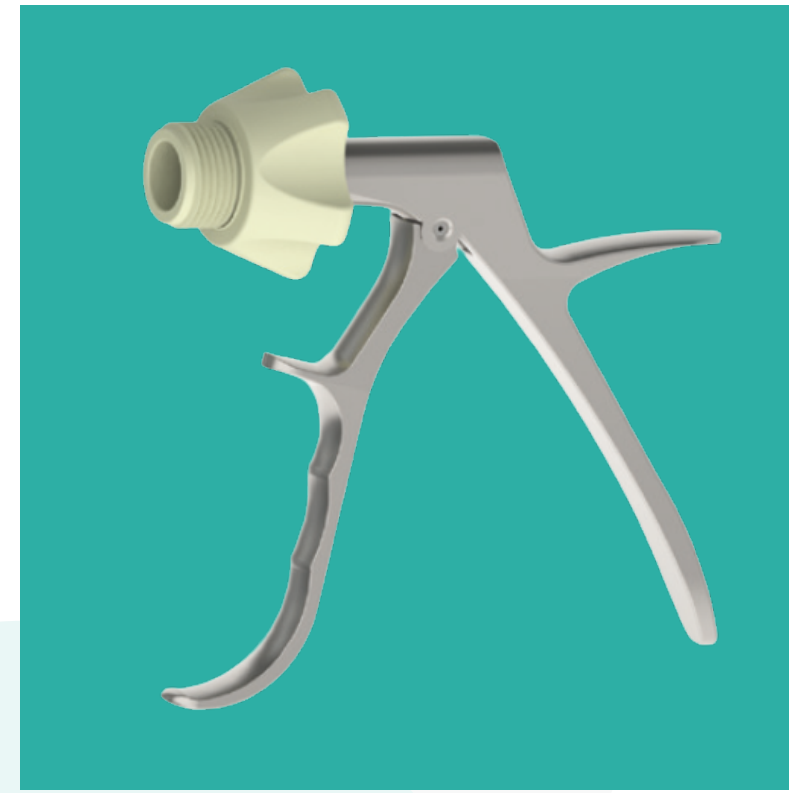

**Empunhaduras p/
Aplicadores de Clip
Ø10mm**
14-2214



**Aplicador de Clip
SLS Micro Ped.
(Branco) Ø5mm**
14-1596 e 14-1597



**Aplicador de Clip
SLS Pequeno Ped.
(Amarelo) Ø5mm**
14-1497, 14-1499, 14-1498
e 14-1523



**Aplicador de Clip
SLS Pequeno/Médio
Ped. (Lilás) Ø5mm**
14-1524, 14-1526, 14-1525 e
14-1527

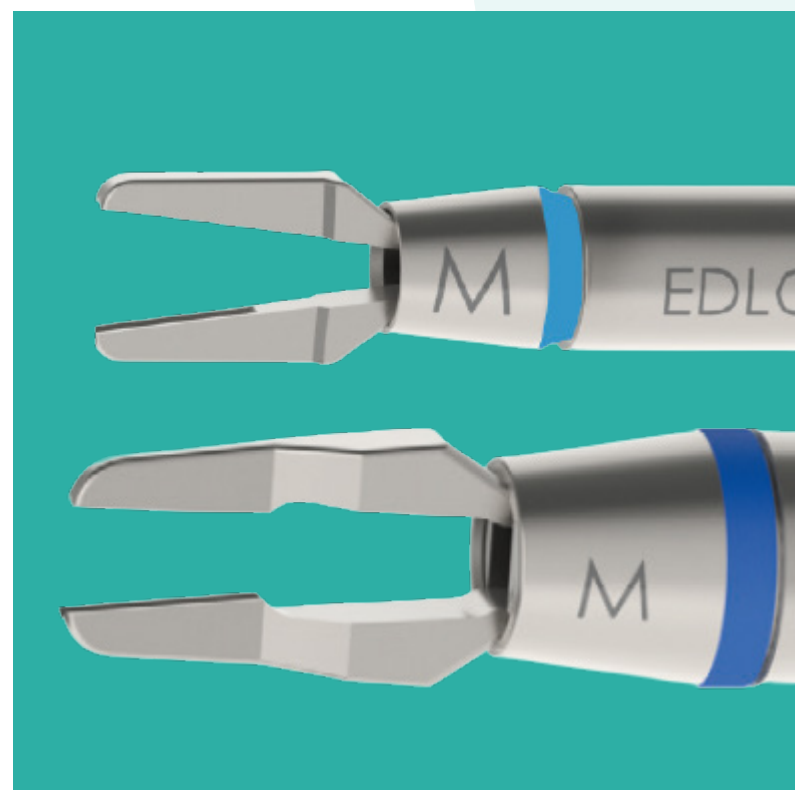

**Aplicador de Clip
SLS Médio (Azul)
Ø6,5mm e Ø10mm**
14-1495, 14-1493, 14-1496,
14-1494, 14-1489, 14-1487,
14-1490 e 14-1488

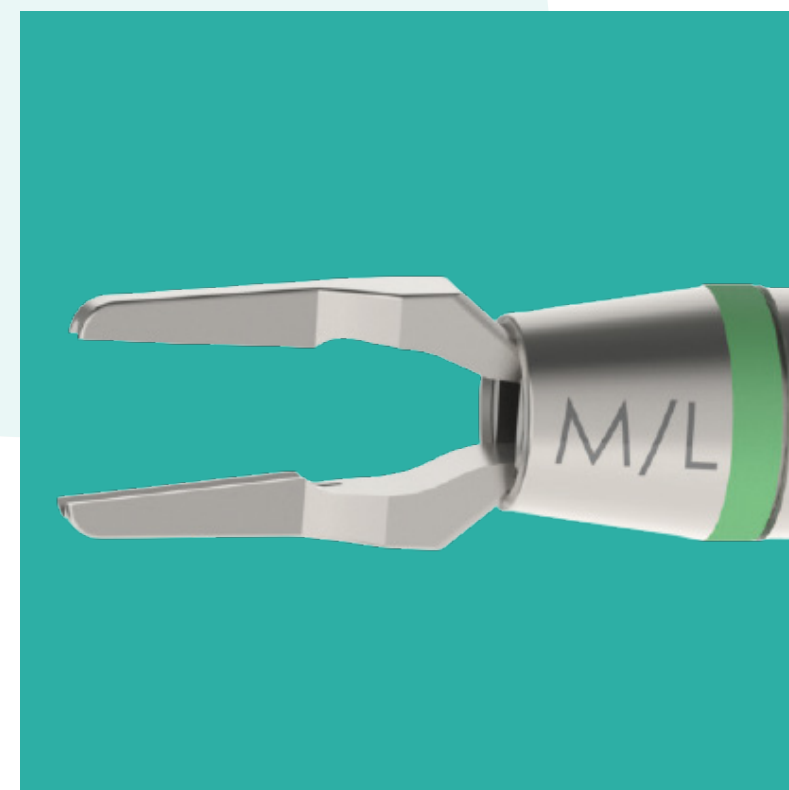

**Aplicador de Clip
SLS Médio/Grande
(Verde) Ø10mm**
14-0454, 14-1484, 14-1536
e 14-2261

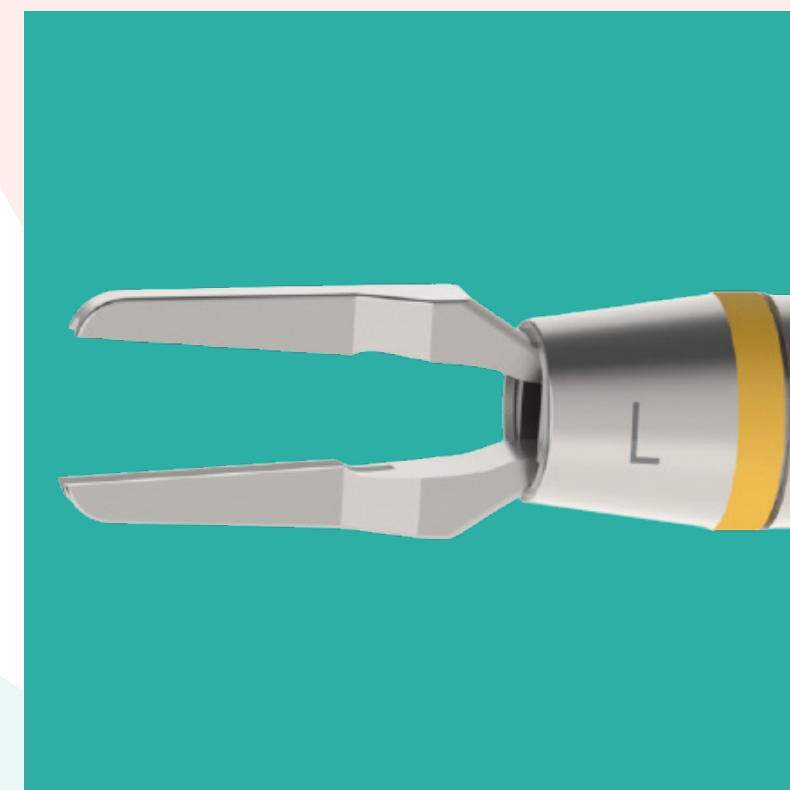

**Aplicador de Clip
SLS Grande
(Laranja) Ø10mm**
14-2385, 14-2387, 14-2386
e 14-2388

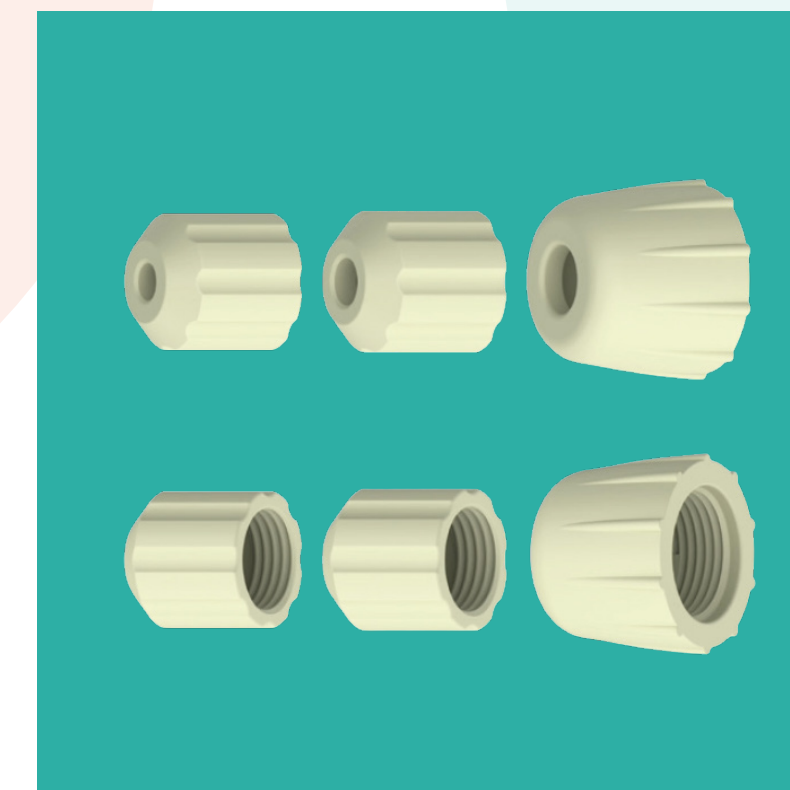

**Porcas p/
Aplicadores de Clip
Ø5mm, Ø6,5mm e
Ø10mm**
14-2211, 14-2215 e 14-2128



Acessórios

ACESSÓRIOS

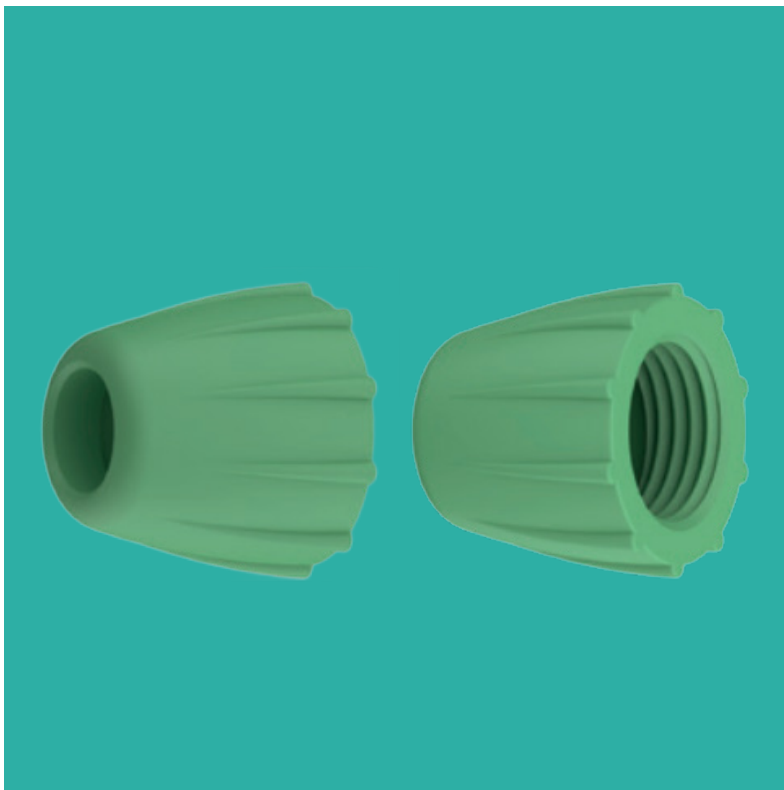

Porca Destak PPS
Ø5mm e Ø10mm

14-1585 e 14-1586

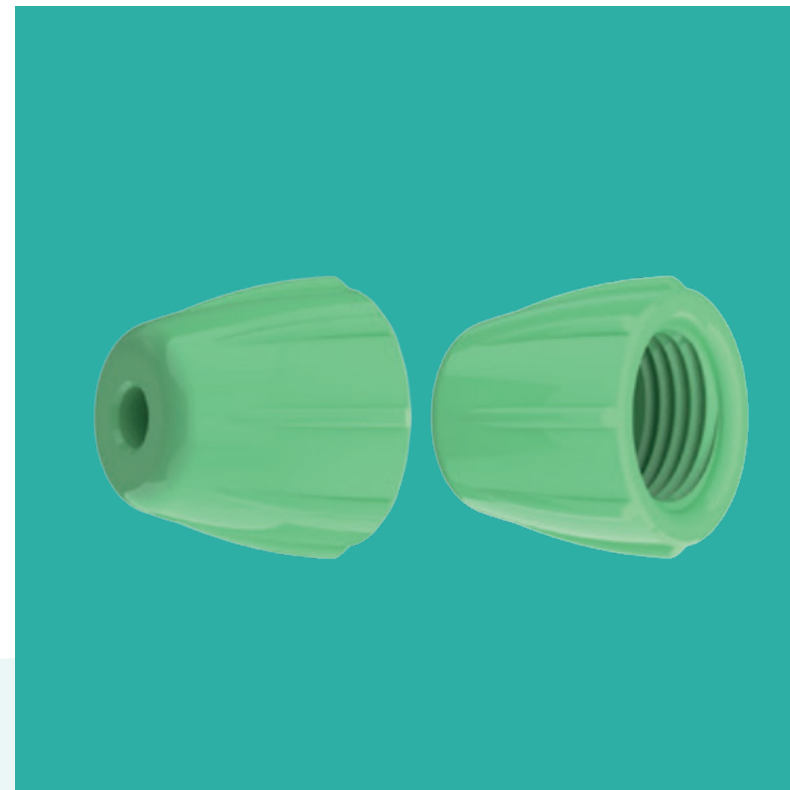

Porca Easy Light
Ø5mm e Ø10mm

14-5200 e 14-5199



**Adaptador p/
Mangueira Ø1/8
Luer-Lock Fêmea**

14-0946



**Adaptador p/ Cabo
Monopolar
Fêmea-Fêmea**

14-0447

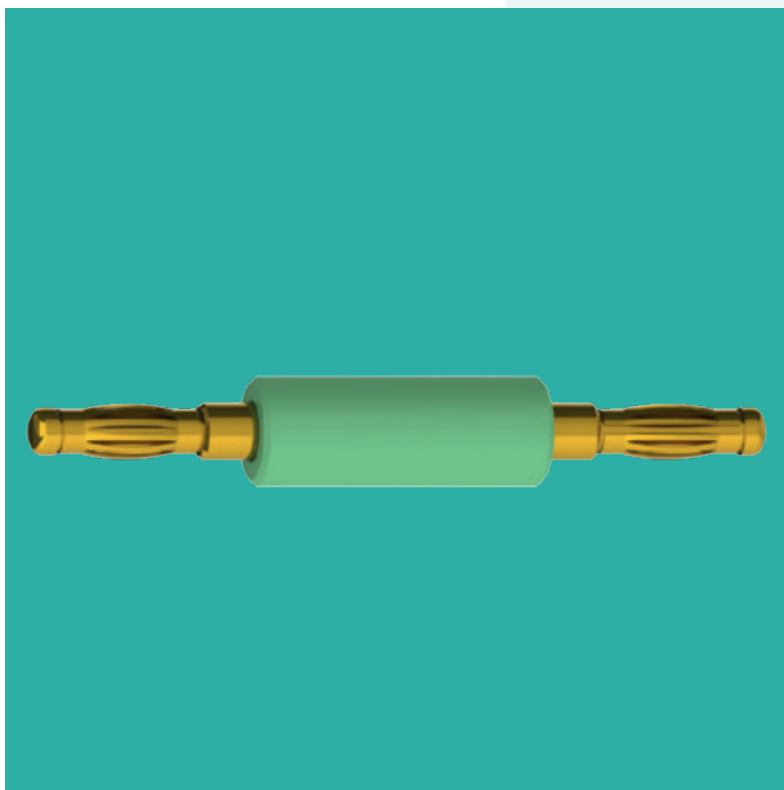

**Adaptador p/ Cabo
Monopolar
Macho-Macho**

14-0445



**Cabo Flexível Pinça
Monopolar
Macho-Macho e
Macho Fêmea**

14-2547 e 14-2540

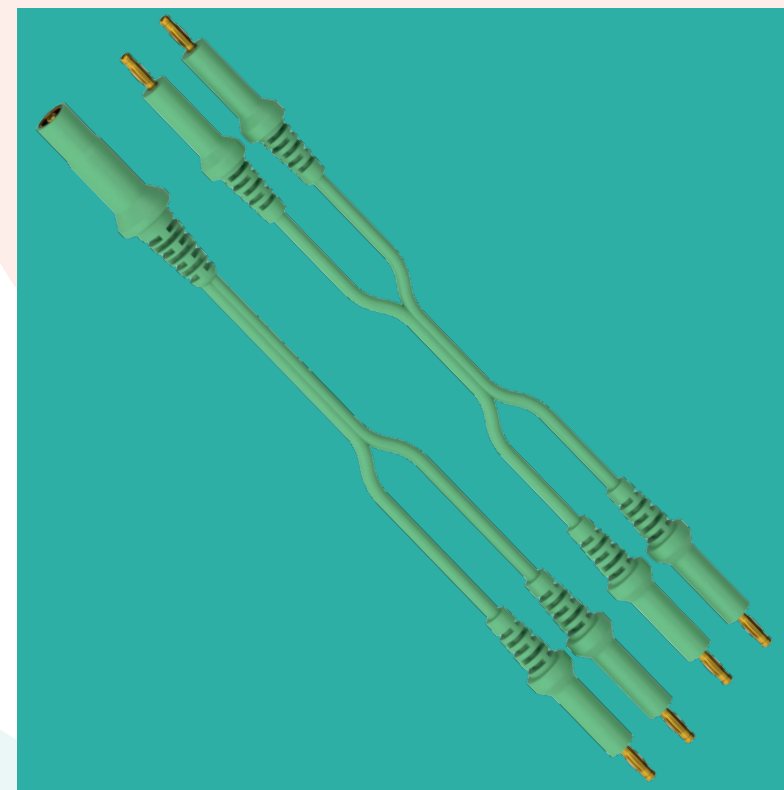

**Cabo Flexível Pinça
Bipolar e Bipolar 2
Plugs**

14-2539 e 14-2548

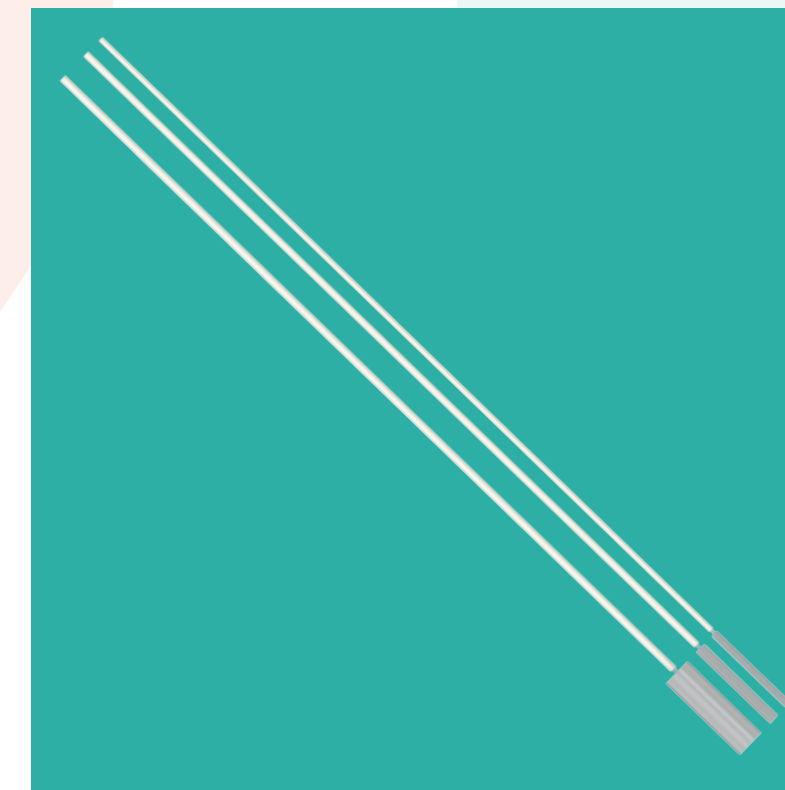

**Kit Escovas p/
Limpeza Produtos.
Conj. c/ 3 Und (3mm,
5mm e 10mm X 42cm)**

14-1593



Maleta p/ Instrument.
Edlo. 53cm X 40cm X
15cm. Peso: 3,210KG

14-2002



Endoscópios Rígidos

ENDOSCÓPIOS RÍGIDOS

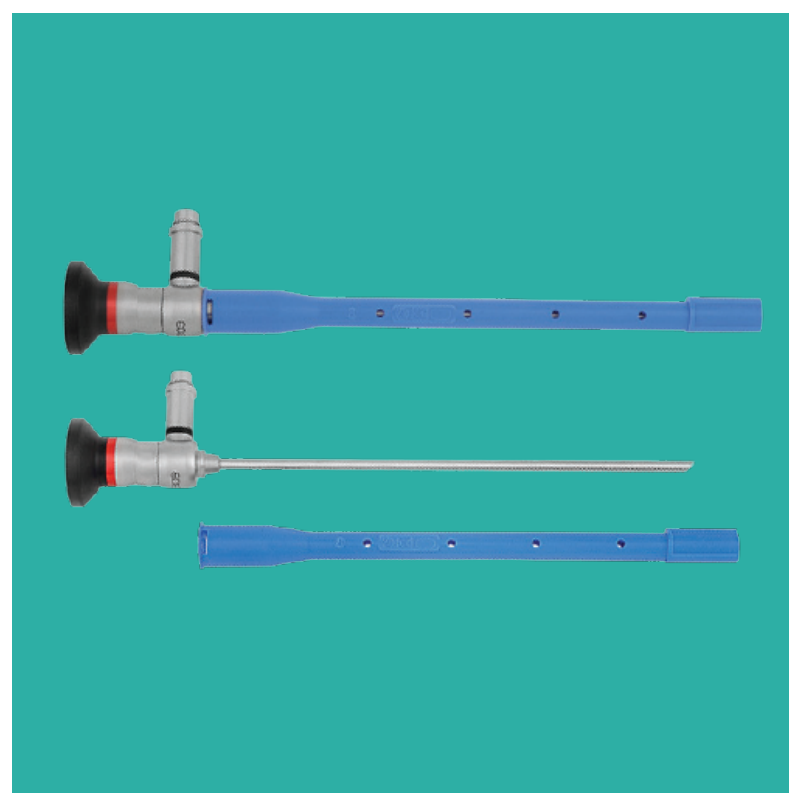

Endoscópio Rígido Artroscopia 4mm 0°, 30°, 45° ou 70°

18-0400, 18-0430, 18-0445, 18-0470



Endoscópio Rígido Laparoscopia 5mm ou 10mm, 0° ou 30°

18-1000, 18-1030, 18-0500 e 18-0530



Endoscópio Rígido Histeroscopia e Cistoscopia 2,9mm ou 4mm, 0°, 30° ou 70°

18-0201, 18-0202, 18-0203, 18-0204 e 18-0205



Cabo Fibra Óptica p/ Fonte de Luz 4,8mm x 2,3m c/ Adaptador

18-0004



Endoscópio Rígido Urologia 6/7,5 Charr 425mm, 7,5/9,8 Charr 425mm e 7,45mm x 200mm 45°

18-0206, 18-0207 e 18-0208

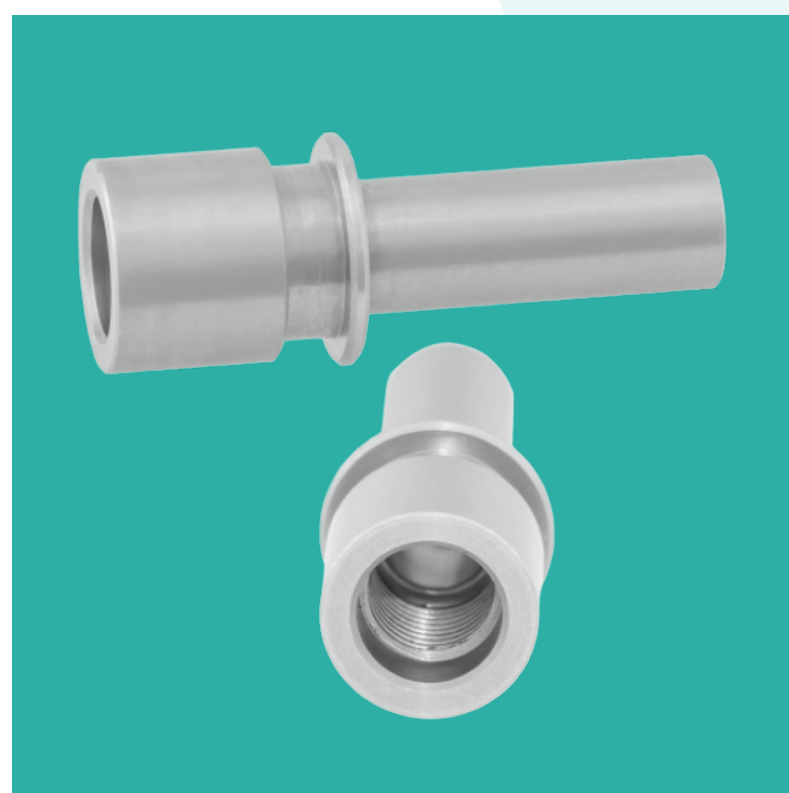

Adaptador p/ Cabo Scholly e Fonte Storm

18-0015



Adaptador p/ Cabo Scholly e Fonte ACM

18-0026



Adaptador p/ Cabo Scholly e Fonte Olympus

18-0025



Adaptador p/ Cabo Storz e Ótica Scholly

18-0037



Adaptador p/ Cabo Scholly e Endoscópio Storz

18-0016

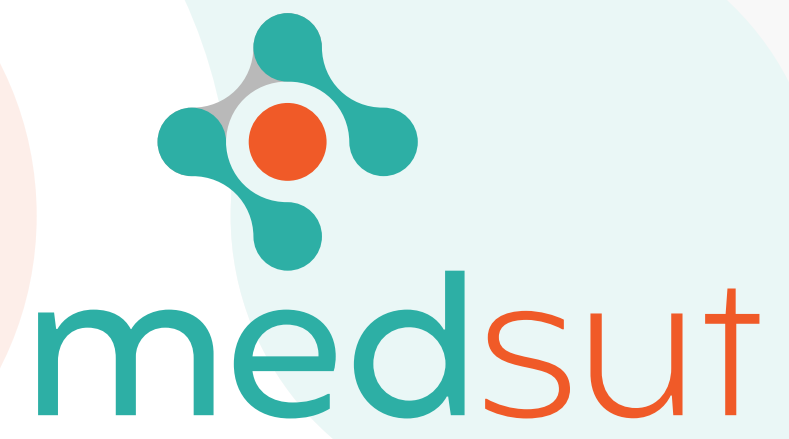

medsut.com.br



Peça agora!

 **(21) 98481-5695**
Atendimento RJ

 **comercial@medsut.com.br**

 **(21) 99886-7268**
Atendimento ES

 **atendimento.es@medsut.com.br**